

CATALOGUE SURGICAL INSTRUMENTS



INTEREST INDUSTRY

 www.interestindustry.com

 info@interestindustry.com

 **+92 318 1769698**



WIDE RANGE OF
SURGICAL
INSTRUMENTS



ABOUT FOR INTEREST INDUSTRY KNOW

Interest Industry established in Sialkot – Pakistan and have more than 37 years of experience in manufacturing Surgical & Veterinary Instruments. This family owned and operated company has export relationships around the globe. The Head Office and Manufacturing unit are one of the largest facility in Sialkot for manufacturing Surgical & Veterinary Instruments. Our company certified ISO 9001, ISO 13485 & CE Mark Our Mission Focussing on ultimate leadership and serving Humanity. We will serve Humanity with high quality, safe and durable products and create a new concept of market leadership....

Thanks & Regards

Interest Industry.

God bless you

Have good day♥

Regards,

Rehan



www.interestindustry.com



info@interestindustry.com



Buck

II-2-101-18

Percussion Hammer
18.5 cm



Buck

II-2-102-18

20cm



Dejerine

II-2-103-20

Percussion Hammer
20cm



Dejerine

II-2-104-21

Percussion Hammer
21cm



Taylor Mod. USA

II-2-105-20

Percussion Hammer
20cm



Wartenberg

II-2-106-19

Pinwheel
18 cm



Pinard
II-1-107-18
Stethoscope
18 cm



Pinard
II-1-108-15
Stethoscope
15cm

Anesthesia



Magill

II-2-101-15

Catheter Introducing Forceps
14.5 cm , 20cm, 25 cm



Miller

II-1-101-18

Laryngoscope Sets



Miller-Baby

II-2-103-00

Laryngoscope Sets



Miller

II-2-104-00

Laryngoscope Blade
Fig. 0, Fig. 1, Fig. 2, Fig. 3, Fig. 4



Guedel-Negus

II-2-105-00

Laryngoscope Sets
Fig. 2, Fig. 3, Fig. 4



Guedel-Negus

II-2-106-00

Laryngoscope Sets
Fig. 1, Fig. 2, Fig. 3, Fig. 4

Anesthesia



Guedel-Negus

II-2-107-01

Laryngoscope Blades
Fig. 1, Fig. 2, Fig. 3, Fig. 4



McIntosh

II-2-108-00

McIntosh



McIntosh

II-2-109-0

Laryngoscope Blades
Fig. 0, Fig. 1, Fig. 2, Fig. 3, Fig. 4



McIntosh

II-2-110-00

Laryngoscope Sets
Fig. 1, Fig. 2, Fig. 3, Fig. 4



Foregger

II-2-111-01

Laryngoscope Blades
Fig. 1, Fig. 2, Fig. 3, Fig. 4



Battery Handle

II-2-112-00

Battery Handle

Anesthesia



McIntosh
MI-2-114-00

Laryngoscope Sets fiber optic
Fig. 1, Fig. 2, Fig. 3



McIntosh
II-2-115-00

Laryngoscope Sets fiber optic
Fig. 1, Fig. 2, Fig. 3



McIntosh
II-2-116-00

Laryngoscope Sets fiber optic
Fig. 1, Fig. 2, Fig. 3



McIntosh
II-2-113-00

Laryngoscope Sets
Fig. 1, Fig. 2, Fig. 3, Fig. 4

Trocars



Universal
II-3-101-04
 Trocar
 14 cm



Nelson
II-3-102-07
 Trocar
 20cm



Lichtwitz
II-3-103-19
 Antrum Trocar
 18.5 cm



Adson
II-3-104-21
 Suction Cannula
 20cm



Frazier
II-3-105-10
 Suction Cannula
 24 cm



Frazier
II-3-106-06
 Suction Cannula
 19.5 cm

Trocars



Poppen
II-3-107-06
 Suction Cannula
 18 cm



Luer
II-3-108-30
 Suction Tube working length 110 mm



Yasargil
II-3-109-15
 Suction Tube working length 150 mm with
 Luer hub



Yankauer
II-3-110-27
 Suction Tube complete with suction tip and
 connector
 31 cm



Yankauer
II-3-111-00
 Suction Tube
 31 cm , 15 cm, 2.5 cm, 10 cm



Poole
II-3-112-22
 Suction Tube
 22cm

Trocars



Poole
II-3-113-22
Suction Tube
22.5 cm



Nuboer
II-3-114-21
Suction Tube
21cm



Nuboer
II-3-115-21
Suction Tube
21cm



Quinke
II-3-116-10
Lumbar Puncture Needle



Tuohy
II-3-117-12
Lumbar Puncture Needle Luer Lock
connection with special tip



Verres
II-3-118-20
Insufflation Cannula Luer Lock connection
15 cm



Verres

II-3-119-20

Insufflation Cannula Luer Lock connection
17 cm

Suture



Kalt

II-4-105-14

Needle Holder
13.5 cm



Barraquer-Troutman

II-4-106-10

Micro Needle Holder
10 cm , 10.5 cm



Arruga

II-4-107-14

Micro Needle Holder
13.5 cm



Barraquer-Troutman

II-4-108-10

Micro Needle Holder
10.5 cm , 11.5cm



Barraquer

II-4-109-11

Micro Needle Holder
11.5cm, 13.5 cm , 14 cm



Barraquer

II-4-110-13

Micro Needle Holder
13.5 cm

Suture



Castroviejo-Fino

II-4-111-01

Micro Needle Holder
13cm



Castroviejo-Fino

II-4-112-01

Micro Needle Holder
13cm



Castroviejo-Fino

II-4-113-01

very delicate jaw with lock
13cm



Castroviejo

II-4-114-14

Micro Needle Holder with lock
Fig.65, Fig.69, Fig.88 L, 14 cm



Castroviejo

II-4-115-14

Micro Needle Holder
14 cm



Castroviejo

II-4-121-14

Micro Needle Holder with lock
14 cm

Suture



Castroviejo

II-4-122-14

Micro Needle Holder
14 cm



Castroviejo

II-4-124-13

Micro Needle Holder with lock



Arruga

II-4-123-16

Needle Holder delicate
16 cm



Castroviejo

II-4-125-12

Micro Needle Holder with lock
12 cm



Derf

II-4-126-12

Needle Holder
12 cm, 13cm

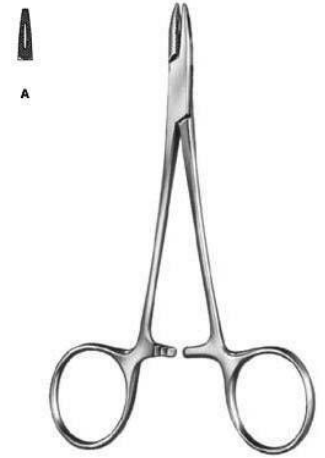

Collier

II-4-127-12

Needle Holder
12.5 cm

Suture

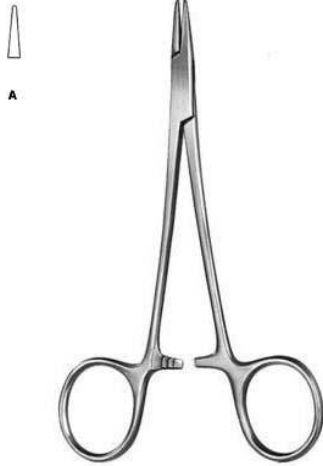

Webster

II-4-128-13

Needle Holder
13cm

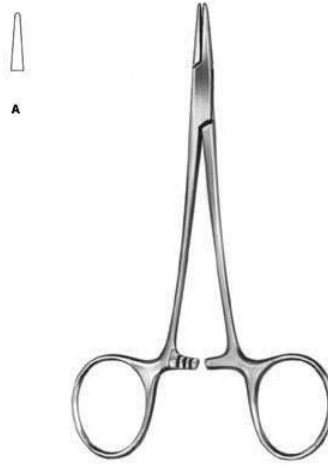

Halsey

II-4-129-13

Needle Holder
13.5 cm



Neivert

II-4-130-13

Neivert
12.5 cm



Metzenbaum

II-4-141-18

Needle Holder one grooved and fenestrated
jaw
18.5 cm



M. G. Hospital

II-4-142-17

Needle Holder
17.5 cm



Mayo-Hegar

II-4-143-14

Needle Holder
14.5 cm , 16 cm , 18.5 cm , 24 cm

Suture



Adson

II-4-140-18

Needle Holder one fenestrated jaw
18 cm



Metzenbaum

II-4-141-18

Needle Holder one grooved and fenestrated
jaw
18.5 cm



M. G. Hospital

II-4-142-17

Needle Holder
17.5 cm

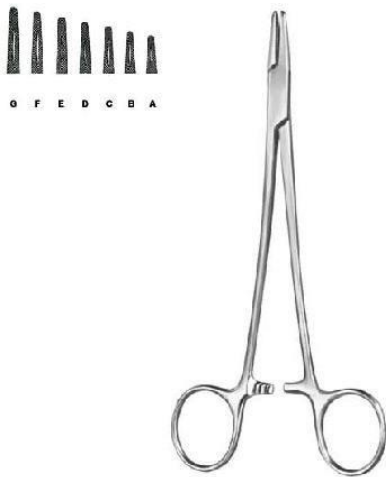

Mayo-Hegar

II-4-143-14

Needle Holder

14.5 cm , 16 cm , 18.5 cm , 20.5 cm , 24 cm
, 26.5 cm

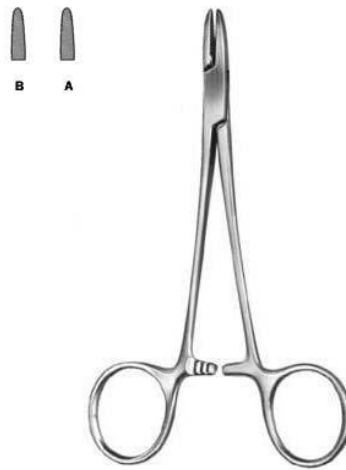

Brown

II-4-145-13

Needle Holder

13cm, 18 cm



Mayo Hegar

II-4-144-16

Needle Holder

16 cm , 18.5 cm , 20.5 cm

Suture

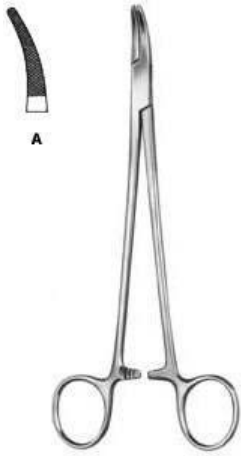

Heaney
II-4-146-21
 Needle Holder
 20.5 cm

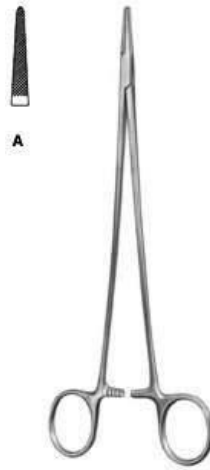

Jamison
II-4-147-23
 Needle Holder
 23.5 cm



Masson
II-4-148-27
 Needle Holder
 26.5 cm

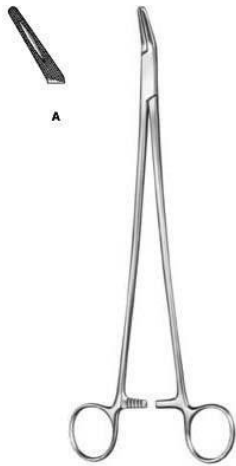

Finochietto
II-4-149-27
 Needle Holder
 26.5 cm



Wangensteen
II-4-150-27
 Needle Holder
 26.5 cm

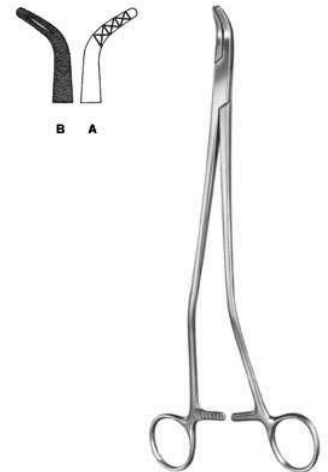

Johnson
II-4-151-27
 Needle Holder
 27 cm

Suture

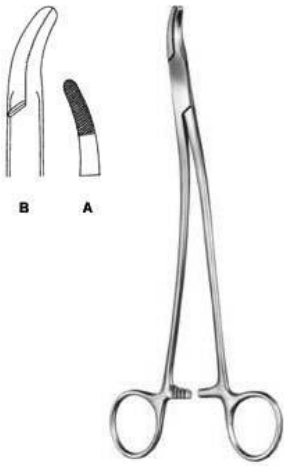

Stratte

II-4-152-23

Needle Holder
23 cm

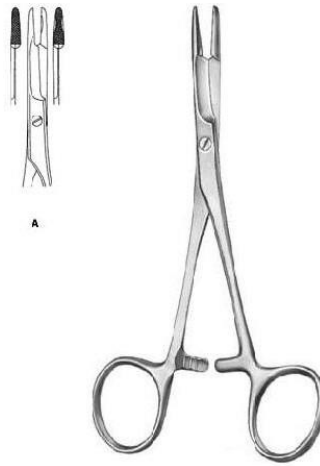

Olsen-Hegar

II-4-153-14

Needle Holder
14 cm

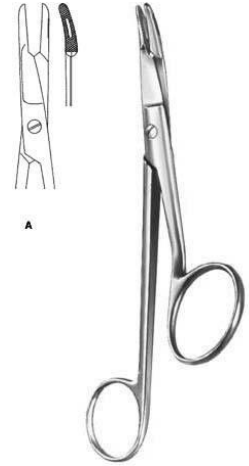

Gillies

II-4-154-16

Needle Holder
16 cm



Crile

II--155-15

Needle Holder
15 cm



Mathieu

II-4-156-14

Needle Holder
14 cm, 17 cm , 20cm



Mathieu

II-4-157-14

Needle Holder
16.5 cm

Suture



Toennis
II-4-158-18

Needle Holder
18.5 cm



Lichtenberg
II-4-159-20

Needle Holder
20cm



Micro Needle Holder
II-4-160-16

Micro Needle Holder
16 cm



Micro Needle Holder
II-4-161

Micro Needle Holder
19 cm



Hepp-Scheidel
II-4-162-18

Micro Needle Holder smooth jaw
18 cm

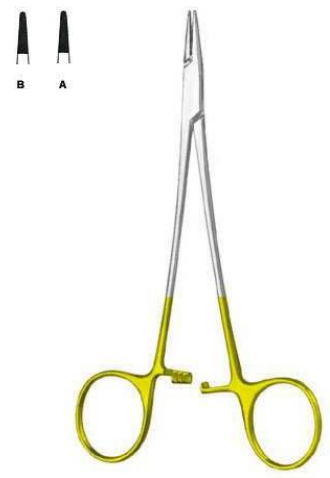

Webster
II-4-163-13

Needle Holder with automatic release
ratchet also for lefthanders
Fig.233, 16 cm , 12 cm, 13cm, 15 cm

Suture



Micro Needle Holder

II-4-164-15

Micro Needle Holder
15 cm, 18 cm, 21cm, 23 cm



JABOMA

II-4-165-18

Micro Needle Holder
18 cm



Castroviejo

II-4-166

Micro Needle Holder
Fig.233, 16 cm , 12 cm, Fig.18 L, 14.5 cm ,
18 cm, 21cm



Arruga

II-4-167

Needle Holder
Fig.233, 16 cm , 12 cm, Fig.18 L, 16 cm



Castroviejo

II-4-168-13

Micro Needle Holder
12.5 cm



Barraquer

II-4-169-13

13 cm

Suture



Barraquer
II-4-170-13

Micro Needle Holder
13 cm



Webster
II-4-171-13

Needle Holder
13 cm

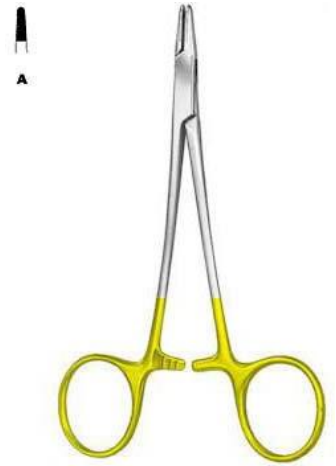

Derf
II-4-173-12

Needle Holder
12 cm

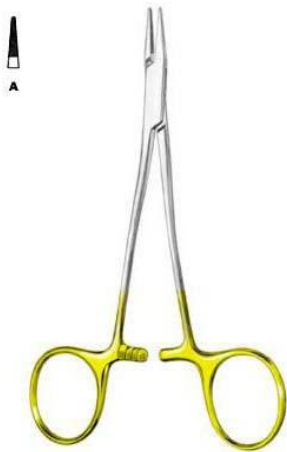

Kilner
II-4-172-13

13 cm



Hegar-Baumgartner
II-4-174-13

Needle Holder
13 cm , 14.5 cm



Halsey
II-4-175-12

Needle Holder
13 cm , 12 cm

Suture



Crile-Wood

II-4-176-15

Needle Holder
15 cm



Sarot

II-4-177-18

Needle Holder
18 cm, 20 cm, 26 cm

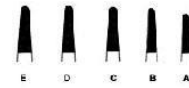

Mayo-Hegar

II-4-178-16

Needle Holder standard profile
16 cm, 18 cm, 20 cm, 24 cm, 26 cm, 30 cm



Heaney

II-4-179-20

Needle Holder
20 cm, 24 cm, 26 cm

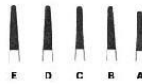

DeBakey

II-4-180-18

Needle Holder delicate pattern mini profile
18 cm, 20 cm, 23 cm, 26 cm, 31 cm



Masson

II-4-181-27

Needle Holder
26.5 cm

Suture

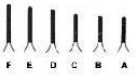

Ryder (Martin)

II-4-182-13

Needle Holder

12.5 cm, 15 cm, 18 cm, 20 cm, 23 cm, 26 cm



Martin

II-4-183-15

Needle Holder mini profile elastic type

15 cm, 17 cm, 20 cm



Wangenstein

II-4-184-27

Needle Holder standard profile

27 cm



Hegar-Vascular

II-4-185-14

Needle Holder micro profile

14 cm, 18.5 cm, 20.5 cm, 23 cm

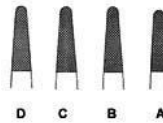

Bozemann

II-4-186-20

Needle Holder standard profile

20.5 cm, 24 cm, 26.5 cm, 29 cm



Hegar

II-4-187-20

Needle Holder standard profile

20 cm, 23.5 cm

Suture

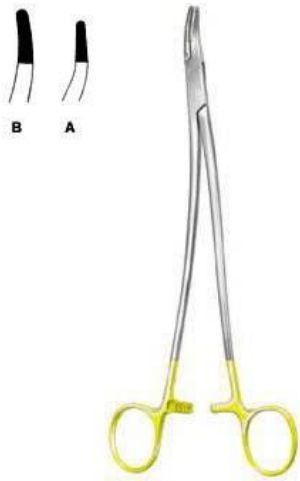

Stratte

II-4-188-22

Needle Holder standard profile
23 cm



Microvascular

II-4-189-00

Needle Holder slender pattern micro profile
14 cm, 17.5 cm, 20 cm, 23 cm



Mathieu

II-4-190-14

Needle Holder
14 cm, 17 cm, 20 cm



Mathieu

II-4-191-14

Needle Holder
14 cm, 17 cm, 20 cm



Mathieu

II-4-192-17

Needle Holder standard profile with interior
ratchet
17 cm, 20 cm, 23 cm



Toennis

II-4-193-18

Needle Holder
18.5 cm

Suture



Lichtenberg
II-4-194-20

Needle Holder lightweight model standard profile
20 cm



Langenbeck
II-4-195-18

Needle Holder
18 cm, 20.5 cm, 23 cm



Zweifel
II-4-196-20

Needle Holder with hinged ratchet standard profile
20.5 cm, 23 cm



Reverdin
II-4-197-15

Reverdin Needle short
14 cm Fig. 1 , 14 cm Fig. 2 , 14 cm Fig. 3,
14 cm Fig. 4

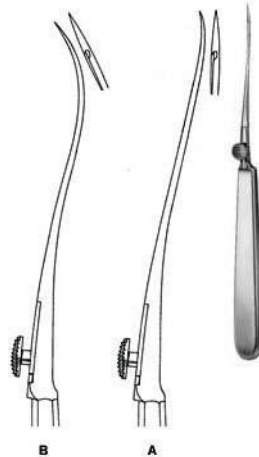

Reverdin
II-4-198-19

Reverdin Needle medium
19.5 cm Fig. 1, 19.5 cm Fig. 2, 19.5 cm Fig.
3, 19.5 cm Fig. 4

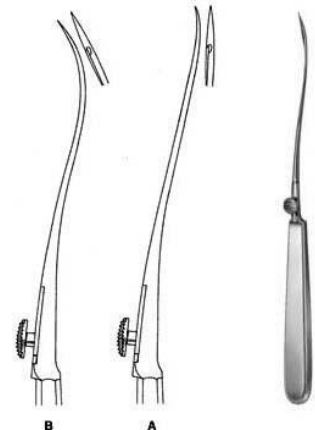

Reverdin
II-4-199-23

Reverdin Needle long
23 cm Fig. 1, 23 cm Fig. 2, 23 cm Fig. 3, 23
cm Fig. 4

Suture

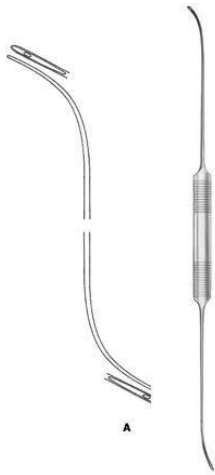

Schmieden-Dick

II-4-201-01

Ligature Needle malleable
29 cm

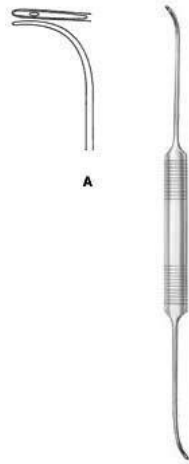

Schmieden

II-4-202-21

Ligature Needle
24 cm



Ligature Needle Malleable

II-4-203-20

Ligature Needle malleable
20.5 cm

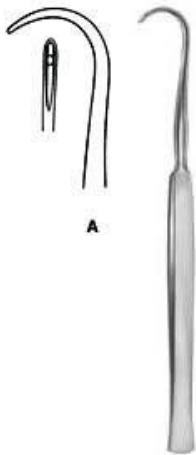

Cooper

II-4-204-19

Ligature Needle
18.5 cm



Kronecker

II-4-205-13

Ligature Needle delicate for right hand
12.5 cm

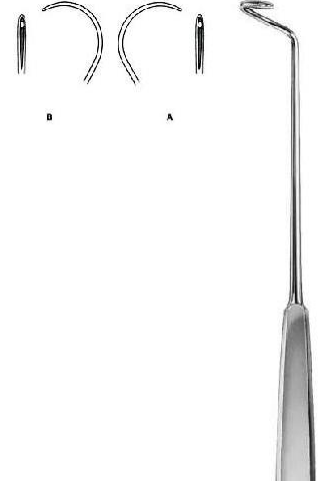

Deschamps

II-4-206-24

24 cm

Suture

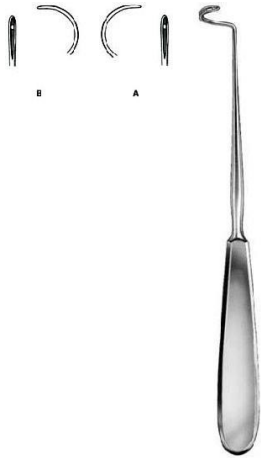

Deschamps

II-4-207-20

Ligature Needle blunt for right hand
20 cm



Deschamps

II-4-208-20

Ligature Needle sharp for right hand
20 cm

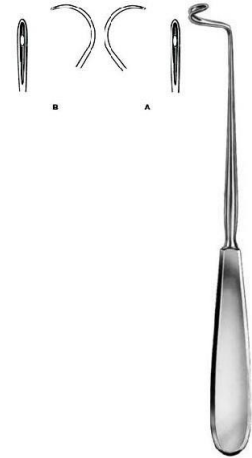

Deschamps

II-4-209-21

Ligature Needle blunt for right hand
20 cm

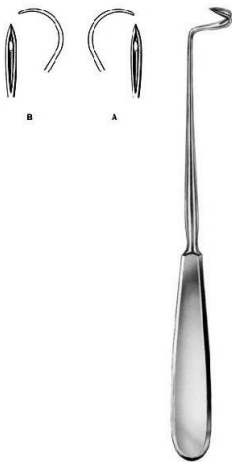

Deschamps

II-4-210-21

Ligature Needle sharp for right hand
20 cm

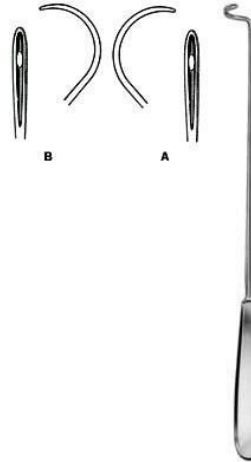

Deschamps

II-4-211-27

Ligature Needle blunt for right hand
27 cm

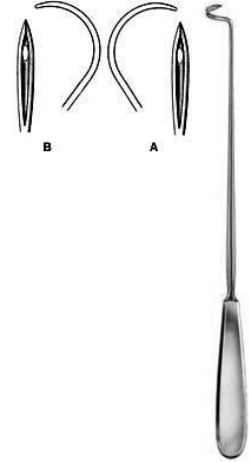

Deschamps

II-4-212-27

Ligature Needle sharp for right hand
27 cm

Suture

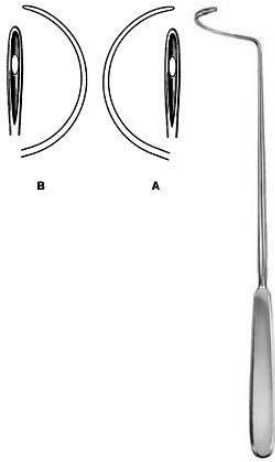

Deschamps
II-4-213-28

28 cm



Deschamps
II-4-214-20

Ligature Needle sharp for right hand
20 cm



Deschamps
II-4-215-20

Ligature Needle blunt for right hand
20 cm



Deschamps
II-4-216-20

Ligature Needle blunt for right hand
21 cm

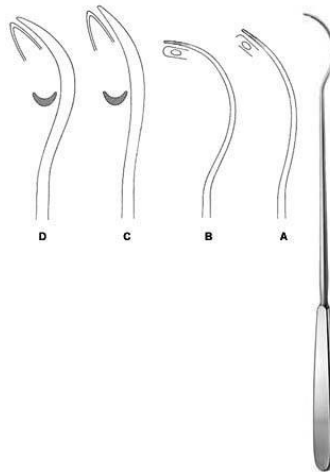

Brunner
II-4-217-30

Ligature Needle
21 cm



Kirschner
II-4-218-25

Ligature Conductor
25.5 cm

Suture

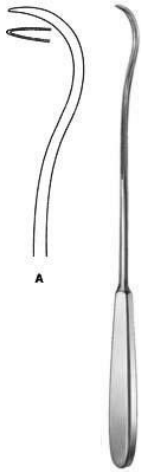

Ligature Conductor

II-4-219-28

Ligature Conductor
28 cm



Modell Wien

II-4-220-23

Ligature Catcher
23.5 cm



Michel

II-4-221-12

Clip Applying Forceps
12 cm



Hegenbarth

II-4-222-12

Clip Applying Forceps
12 cm

Scalpels



Dissecting Knife

II-5-101-01

Dissecting Knife with metal handle
15 cm, 15.5 cm, 16 cm , 17 cm



Autopsy Knife

II-5-102-10

Autopsy Knife
25.5 cm

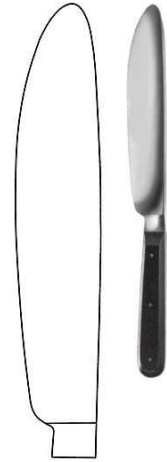

Walb

II-5-104-17

Post Mortem Knife

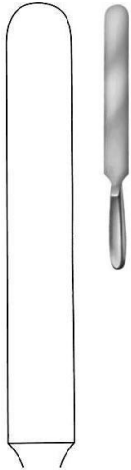

Virchow

II-5-105-20

Virchow
28.5 cm, 33.5 cm, 38 cm



Scalpel Handle

II-5-108-04

Scalpel Handle
13.5 cm



Scalpel Handle

II-5-109-34

Scalpel Handle
16 cm

Scalpels



Scalpel Handle

II-5-110-41

Scalpel Handle
21cm



Scalpel Handle

II-5-111-45

Scalpel Handle
21cm



Collin

II-5-112-08

Scalpel Handle with hollow handle
13.5 cm



Collin

II-5-113-09

Scalpel Handle with hollow handle
14.5 cm



Scalpel Handle

II-5-114-03

Scalpel Handle
12 cm



Scalpel Handle

II-5-115-04

Scalpel Handle
12 cm

Scalpels



Scalpel Handle

II-5-116-05

Scalpel Handle
12 cm



Scalpel Handle

II-5-117-31

Scalpel Handle
21.5 cm



Scalpel Handle

II-5-118-35

Scalpel Handle
21cm



Scalpel Handle

II-5-119-07

Scalpel Handle
16 cm



Scalpel Handle

II-5-120-71

Scalpel Handle
12.5 cm



Scalpel Handle

II-5-121-03

Scalpel Handle
15.5 cm

Scalpels



Amputation Knife

II-5-127-16

Amputation Knife
29 cm



Amputation Knife

II-5-128-19

Amputation Knife
32.5 cm



Catlin

II-5-129-16

Interosseous Knife with hollow handle
29 cm



Resection Knife

II-5-130-06

Resection Knife
18 cm



Langenbeck

II-5-131-05

Resection Knife
18 cm



Langenbeck

II-5-132-05

Langenbeck
18 cm

Scalpels



Razor Knife

II-5-133-00

Razor Knife hollow blades on both sides cutting length 75mm



Schink

II-5-134-00

Dermatome complete with 2 skin fixing plates and one blade
31 cm



Schink

II-5-135-01

Spare Blade spare blade for KE-05-134-00

&nb



Schink

II-5-136-02

Skin Fixing Plate for KE-05-134-00

Scissors



Standard BL / BL Straight

II-5-201-13

Operating Scissor Special Price:
\$1.25

12 cm, 13cm, 14.5 cm , 16.5 cm, 18.5 cm ,
20.5 cm



Standard SH / BL STR

II-5-202-13

Operating Scissors

12 cm, 13cm, 14.5 cm , 16.5 cm, 18.5 cm ,
20.5 cm



Standard SH / SH STR

II-5-20413

Operating Scissors

12 cm, 13cm, 14.5 cm , 16.5 cm



Standard BL / BL Curved

II-5-205-13

Operating Scissors

12 cm, 13cm, 14.5 cm , 16.5 cm, 18.5 cm ,
20.5 cm

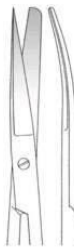

Standard SH / BL Curved

II-5-206-13

Operating Scissors

12 cm, 13cm, 14.5 cm , 16.5 cm, 18.5 cm ,
20.5 cm



Standard SH / SH Curved

II-5-207-13

Operating Scissors

12 cm, 13cm, 14.5 cm , 16.5 cm

Scissors



Standard BL / BL Curved

II-5-208-14

Operating Scissors delicate

14.5 cm



Incision Scissor

II-5-209-14

Operating Scissor

14.5 cm



Deaver

II-5-210-14

Operating Scissors



Mayo

II-5-211-15

Dissecting Scissors

14.5 cm , 15 cm, 17 cm , 23.5 cm



Mayo

II-5-212-23

Dissecting Scissors

23 cm , 22.5 cm, 28 cm



Mayo-Harrington

II-5-213-22

Dissecting Scissors

23 cm , 22.5 cm, 28 cm

Scissors

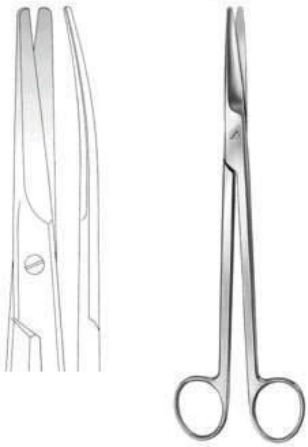

Mayo-Harrington
II-5-214-22

Dissecting Scissors cur.
22.5 cm, 23 cm , 28 cm

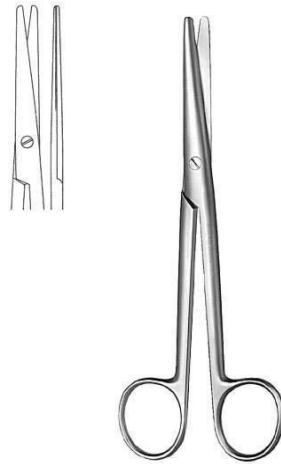

Mayo-Stille
II-5-215-17

Dissecting Scissors str.
15 cm, 17 cm

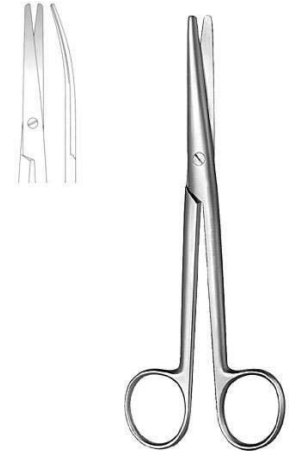

Mayo-Stille
II-5-216-15

Dissecting Scissors cur.
15 cm, 17 cm

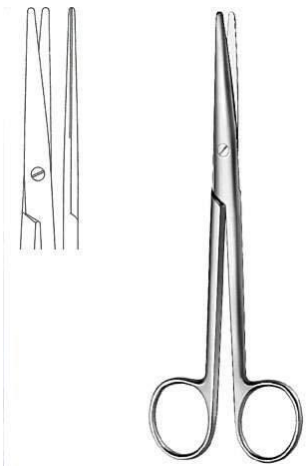

Mayo-Stille
II-5-217-19

16 cm, 19.5 cm , 21.5 cm

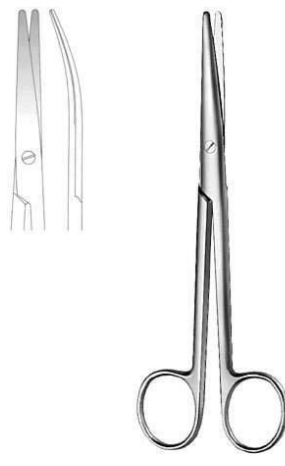

Mayo-Stille
II-5-218-16

Dissecting Scissors cur.
16 cm, 19.5 cm , 21.5 cm



Mayo-Noble
II-5-219-17

Gynecological Scissors
16.5 cm

Scissors



Sims

II-5-220-23

Gynecological Scissors str.

20cm, 23 cm



Sims

II-5-221-20

Gynecological Scissors cur.

20cm, 23 cm



Kelly

II-5-222-16

Operating Scissors

16 cm



Doyen

II-5-223-17

Gynecological Scissors

18.5 cm



Sims-Siebold

II-5-224-24

24.5 cm



Sims-Siebold

II-5-225-24

Gynecological Scissors

24.5 cm

Scissors



Wertheim
II-5-226-23

Gynecological Scissors

20cm, 23 cm



Metzenbaum
II-5-229-15

Dissecting Scissors

15.5 cm



Metzenbaum
II-5-227-11

Dissecting Scissors

11



Metzenbaum-Nelson
II-5-230-20

Dissecting Scissors

18 cm, 20.5 cm, 23 cm , 26 cm, 28.5 cm, 31 cm



Metzenbaum
II-5-228-14

Dissecting Scissors

14.5 cm



Metzenbaum-Nelson
II-5-231-20

Dissecting Scissors

18 cm, 20.5 cm

Scissors

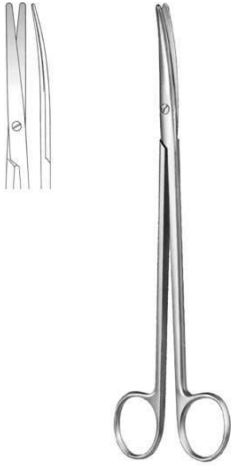

Metzenbaum-Nelson

II-5-232-20

Dissecting Scissors

18 cm, 20.5 cm, 23 cm , 26 cm, 28.5 cm, 31 cm



Metzenbaum

II-5-233-14

Dissecting Scissors toothed

14.5 cm



Nerve Operating Scissor

II-5-234-15

Dissecting Scissors

15.5 cm

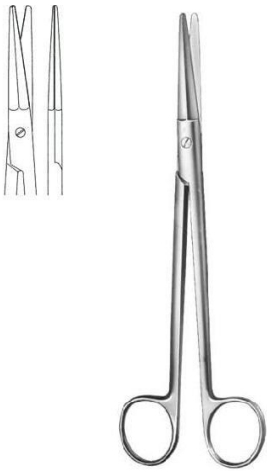

Gorney

II-5-235-19

Face-lift Scissors str.

12.5 cm, 19.5 cm

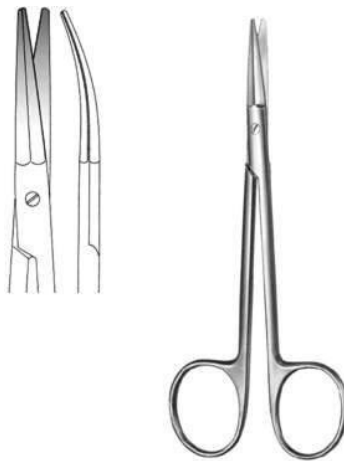

Gorney

II-5-236-19

Face-lift Scissors cur.

19.5 cm



Aston

II-5-237-17

Face-lift Scissors

17 cm

Scissors



Lexer

II-5-238-16

Dissecting Scissors

16 cm



Cinelli

II-5-239-14

Nasal Scissors

11.5cm, 14 cm



Thorek

II-5-240-19

Dissecting Scissors

18.5 cm



Lexer-Baby

II-5-241-10

Dissecting Scissors

10 cm



Lexer-Fino

II-5-242-16

Delicate Dissecting Scissors
slender pattern

16.5 cm



Metzenbaum-Fino

II-5-243-14

Delicate Dissecting Scissors
slender pattern

14.5 cm

Scissors



Metzenbaum-Fino

II-5-244-14

Delicate Dissecting Scissors

14.5 cm



Metzenbaum-Fino

II-5-245-14

Delicate Dissecting Scissors

<
14.5 cm



Metzenbaum-Fino

II-5-246-14

Delicate Dissecting Scissors

14.5 cm

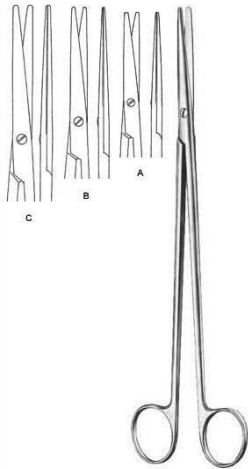

Metzenbaum-Fino

II-5-247-18

Delicate Dissecting Scissors
slender pattern

18 cm, 20cm, 23 cm

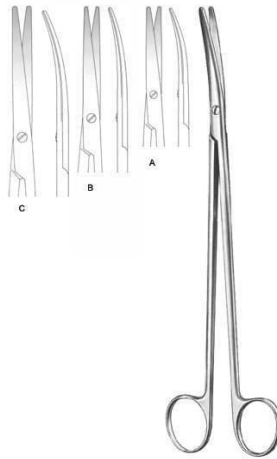

Metzenbaum-Fino

II-5-248-18

Delicate Dissecting Scissors
slender pattern

18 cm, 20cm, 23 cm

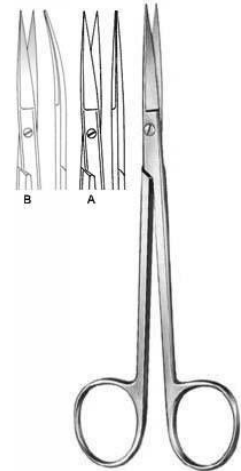

Sanvenero

II-5-250-14

Operating Scissors

14 cm

Scissors

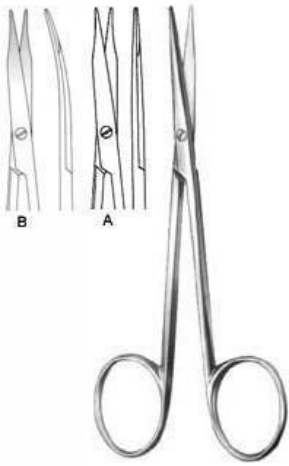

Fine Operating Scissors
II-5-251-11
 Fine Operating Scissors
 11.5cm

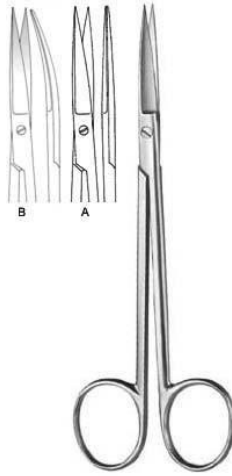

Joseph
II-5-252-14
 Operating Scissors
 14.5 cm

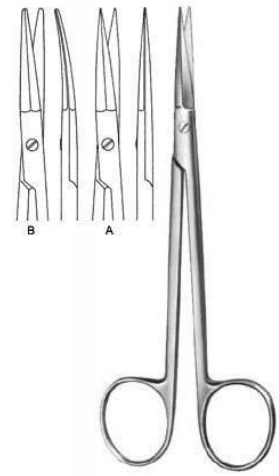

Peck-Joseph
II-5-253-14
 Face-lift Scissors
 14.5 cm

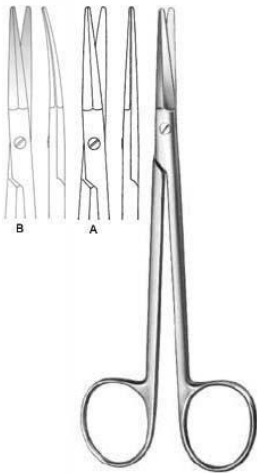

Peck-Joseph
II-5-254-14
 Face-lift Scissors
 14.5 cm



Shea Vein Graft
II-5-255-12
 Dissecting Scissors
 12 cm

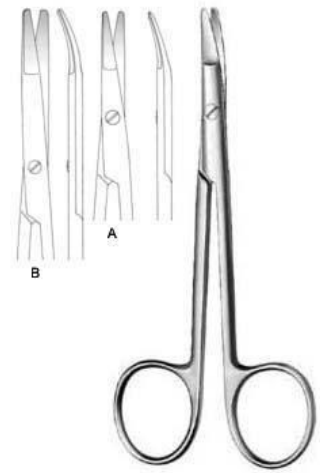

Kilner
II-5-256-12
 Dissecting Scissors
 12 cm, 15 cm

Scissors

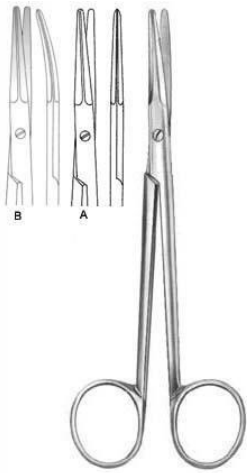

Dissecting Scissors

II-5-257-14

Dissecting Scissors
14.5 cm

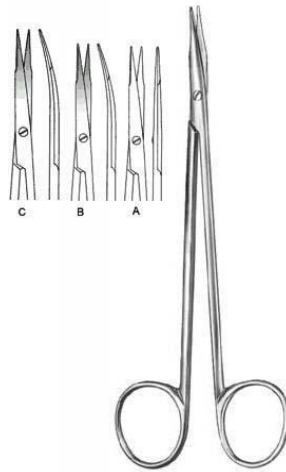

Reynolds

II-5-258-15

Dissecting Scissors
15.5 cm, 18 cm



Jameson

II-5-259-14

Dissecting Scissors
15.5 cm



Jameson

II-5-260-14

Dissecting Scissors
15.5 cm



Vascular Scissors

II-5-261-19

Vascular Scissors
19 cm

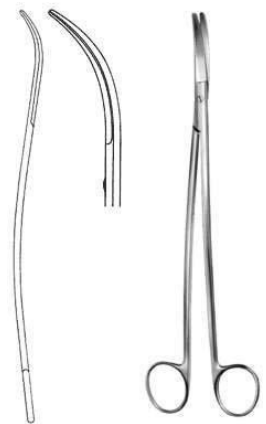

Vascular Scissors

II-5-262-24

Vascular Scissors
19 cm , 25.5 cm

Scissors

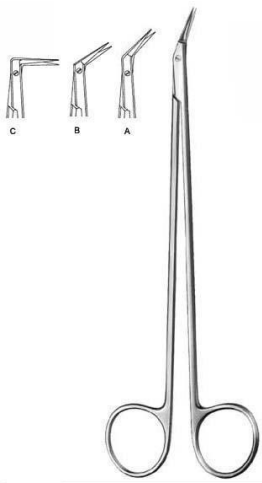

Diethrich

II-5-263-25

vascular Scissors
17.5 cm, 18.5 cm , 19 cm

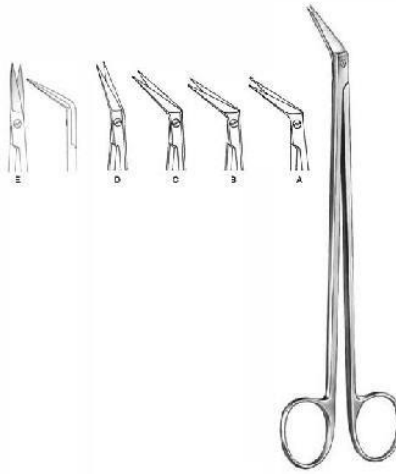

DeBakey

II-5-264-45

vascular Scissors
16 cm, 16.5 cm

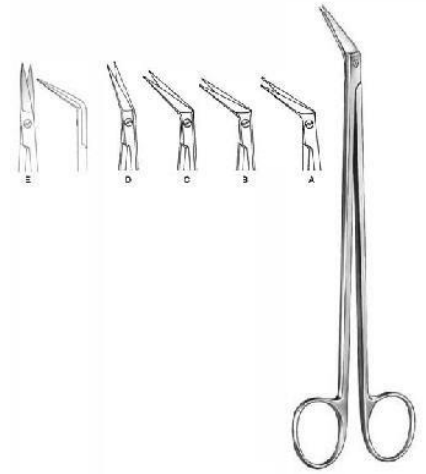

Potts-Smith

II-5-265-19

Vascular Scissors
18 cm, 18.5 cm , 19 cm



Coronary Scissors

II-5-267-45

Cardiovascular Surgery Scissors
18 cm



Coronary Scissors

II-5-267-45

Cardiovascular Surgery Scissors
18 cm



Coronary Scissors

II-5-268-60

Cardiovascular Surgery Scissor
18 cm

Scissors



Coronary Scissors

II-5-269-90

Cardiovascular Surgery Scissor

18 cm



Coronary Scissors

II-5-272-25

Cardiovascular Surgery Scissor

18 cm



Coronary Scissors

II-5-270-00

Cardiovascular Surgery Scissor

18 cm



Coronary Scissors

II-5-273-45

Cardiovascular Surgery Scissor

18 cm



Coronary Scissors

II-5-271-00

Cardiovascular Surgery Scissor

18 cm



Coronary Scissors

II-5-274-90

Cardiovascular Surgery Scissor

18 cm

Scissors



Schmieden-Taylor

II-5-275-17

Dura Scissors

15 cm



Strully

II-5-276-22

Neurosurgical Scissors

22.5 cm



Toennis-Adson

II-5-277-17

Dissecting Scissors

17.5 cm



Good

II-5-279-19

Tonsil Scissors

19.5 cm



Fomon

II-5-282-15

Nasal Scissors

15 cm



Cottle

II-5-283-16

Nasal Scissors

16

cm

Scissors



Heymann

II-5-284-18

Nasal Scissors
18.5 cm



Heymann

II-5-285-18

Nasal Scissors
18.5 cm



Converse

II-5-286-11

Nasal Scissors blunt & sharp
10.5 cm



Waldmann

II-5-287-18

Episiotomy Scissors
18 cm



Braun-Stadler

II-5-268-60

Episiotomy Scissors
14.5 cm



Braun-Stadler

II-5-289-22

Episiotomy Scissors

22cm

Dressing & Tissue Forceps



McIndoe
II-5-405-12

Dressing Forceps

15 cm



Taylor
II-5-410-17

Dressing Forceps

12.5 cm, 15 cm



Waugh
II-5-408-20

Dressing Forceps

20cm



Taylor
II-5-411-17

Dressing Forceps

17 cm



Semken
II-5-409-12

Dressing Forceps

12.5 cm, 15 cm



Taylor
II-5-412-17

Dressing Forceps

18.5 cm

Dressing & Tissue Forceps



Dressing Forceps
II-5-413-06
Dressing Forceps
15.5 cm



Gerald
II-5-414-18
Dressing Forceps
15.5 cm



Cushing
II-5-415-17
Dressing Forceps
17.5 cm



Potts-Smith
II-5-416-18
Dressing Forceps
18 cm, 21cm, 24.5 cm



Bonney
II-5-417-17
Dissecting Forceps
17.5 cm



Gerald
II-5-418-17
17.5 cm

Dressing & Tissue Forceps



Gillies

II-5-419-15

Dissecting Forceps

15.5 cm



McIndoe

II-5-420-15

Dressing Forceps

15 cm



Semken

II-5-421-16

Dissecting Forceps

15.5 cm, 17.5 cm



Adson-Brown

II-5-422-12

Dissecting Forceps

12 cm



Adson

II-5-423-12

Dissecting Forceps

12 cm, 15 cm



Adson

II-5-424-12

Dressing Forceps

12 cm, 15 cm

Dressing & Tissue Forceps



Cushing
II-5-425-17

Dressing Forceps

17.5 cm



Potts-Smith
II-5-428-15

Dressing Forceps

16 cm, 18.5 cm , 20cm, 23 cm , 25 cm



Cushing
II-5-426-18

Dressing Forceps

17 cm



Oehler
II-5-429-14

Dissecting Forceps

14.5 cm , 16 cm, 18 cm, 20cm, 25 cm



Cushing-Taylor
II-5-427-18

Dressing Forceps

18.5 cm



Wangensteen
II-5-430-15

Dressing Forceps

15 cm, 23 cm

Dressing & Tissue Forceps



DeBakey
II-5-421-16

Atraumatic Dressing Forceps

16 cm, 20cm, 24.5 cm



DeBakey
II-5-432-16

Atraumatic Dressing Forceps

16 cm, 20cm, 24 cm



Dissecting Forceps
II-5-433-10

Dissecting Forceps

10.5 cm , 11.5cm, 13 cm , 14.5 cm , 16 cm,
18 cm, 20cm, 23 cm , 25 cm , 30.5 cm

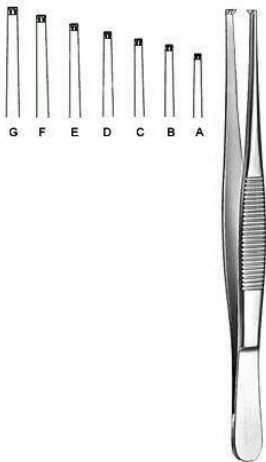

Dissecting Forceps
II-5-434-11

Dissecting Forceps

12 cm, 13 cm , 14.5 cm , 15.5 cm, 18 cm,
20cm, 24.5 cm



Dissecting Forceps
II-5-435-14

Dissecting Forceps

14.5 cm , 16 cm



Dissecting Forceps
II-5-436-14

Dissecting Forceps

14.5 cm , 16 cm

Dressing & Tissue Forceps



Dissecting Forceps
II-5-437-13

Dissecting Forceps

13 cm , 14.5 cm , 16 cm , 20cm



Dissecting Forceps
II-5-438-13

Dissecting Forceps

13 cm , 14.5 cm



Stille
II-5-439-15

Dissecting Forceps

15 cm



Stille
II-5-440-15

Dissecting Forceps

15 cm



Stone
II-5-441-15

Dissecting Forceps

15 cm



Lerche
II-5-442-15

Dissecting Forceps

15 cm

Dressing & Tissue Forceps

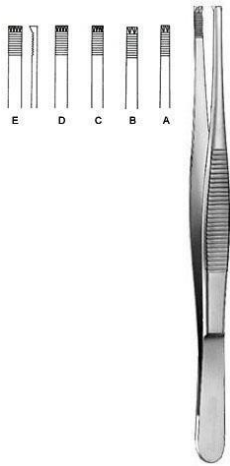

Adlerkreutz

II-5-443-15

Dissecting Forceps

15.5 cm, 20.5 cm, 16 cm, 20cm, 25 cm

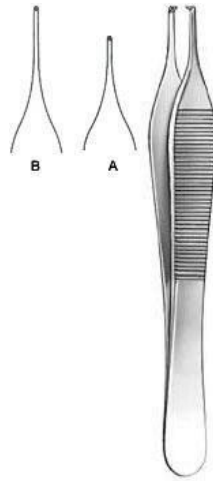

Adson

II-5-444-12

Dissecting Forceps

12 cm, 15 cm



Gillies

II-5-445-15

Dissecting Forceps

15.5 cm



Waugh

II-5-446-20

Dissecting Forceps

20.5 cm



Semken

II-5-447-12

Dissecting Forceps

12.5 cm, 15 cm



Taylor

II-5-448-17

Dissecting Forceps

17.5 cm

Dressing & Tissue Forceps



Splinter Forceps Smooth Jaw

II-5-467-12

Splinter Forceps smooth jaw
12.5 cm



Splinter Forceps Smooth Jaw

II-5-468-12

Splinter Forceps smooth jaw
12.5 cm



Splinter Forceps

II-5-469-12

Splinter Forceps
12.5 cm



Splinter Forceps

II-5-470-12

Splinter Forceps
12.5 cm



Micro Tying Forceps

II-5-471-16

Micro Tying Forceps
15.5 cm



Microscopic Forceps Super Light, Blunt

II-5-472-10

Microscopic Forceps super light, blunt
10 cm

Dressing & Tissue Forceps



Microscopic Forceps

II-5-473-10

Microscopic Forceps
10 cm



Shaaf

II-5-474-09

Splinter Forceps
9.5 cm



Littauer

II-5-475-08

Cilia Forceps
8.5 cm



Cilia Forceps

II-5-476-09

Cilia Forceps
8.5 cm



Douglas

II-5-477-09

Cilia Forceps
9 cm



Douglas

II-5-478-09

Cilia Forceps
9 cm



Beer

II-5-479-09

Cilia Forceps

9 cm

Splinter Forceps



Phaneuf

II-5-501-21

Hysterectomy Forceps
20.5 cm



Wertheim-Cullen

II-5-502-21

Vaginal Clamp
21 cm

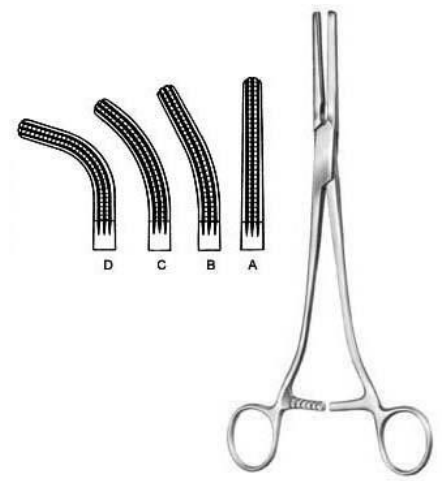

Rogers

II-5-503-10

Hysterectomy Forceps
21.5 cm Fig. 1, 21 cm Fig. 2, 20.5 cm Fig. 3,
20 cm Fig. 4



Moynihan

II-5-504-23

Hysterectomy Forceps
23 cm



Moynihan

II-5-505-24

Hysterectomy Forceps
23.5 cm



Wertheim

II-5-506-25

Hysterectomy Forceps
26 cm

Splinter Forceps

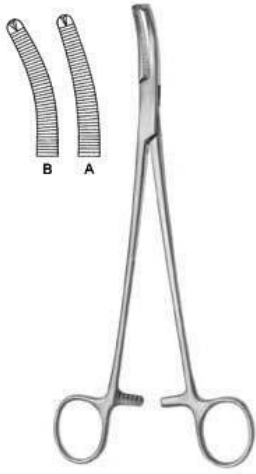

Wertheim

II-5-507-22

Hysterectomy Forceps
22.5 cm



Mikulicz, Baby

II-5-508-14

Peritoneum Forceps
14.5 cm



Mikulicz

II-5-509-18

Peritoneum Forceps
20.5 cm



Mikulicz

II-5-510-20

Peritoneum Forceps
18.5 cm



Mikulicz

II-5-511-20

Peritoneum Forceps
20cm



Mikulicz

II-5-512-21

Peritoneum Forceps
20.5 cm



Faure

II-5-513-20

Peritoneum Forceps

21 cm

Haemostatic Forceps

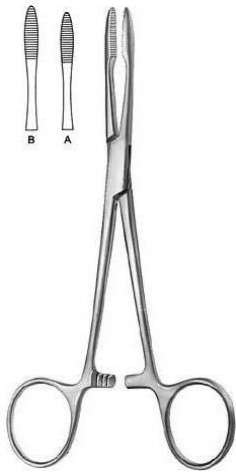

Pean

II-5-601-14

Haemostatic Forceps

14.5 cm , 16 cm

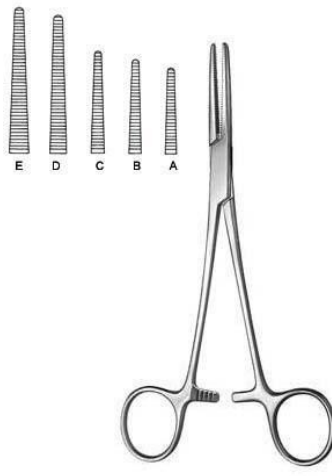

Spencer-Wells

II-5-602-13

Haemostatic Forceps

13 cm , 14 cm, 15.5 cm, 18.5 cm , 20 cm

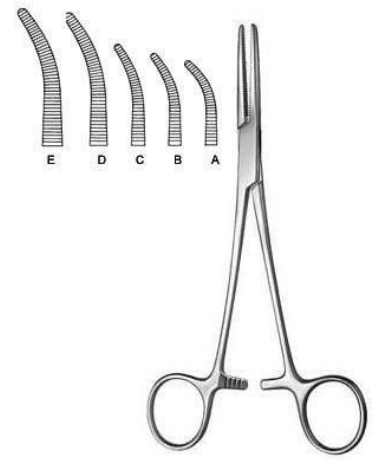

Spencer-Wells

II-5-603-13

Haemostatic Forceps

13 cm , 14 cm, 15 cm, 18 cm, 20 cm



Chaput

II-5-604-13

Haemostatic Forceps

12.5 cm



Tuffier

II-5-605-13

Haemostatic Forceps

12.5 cm

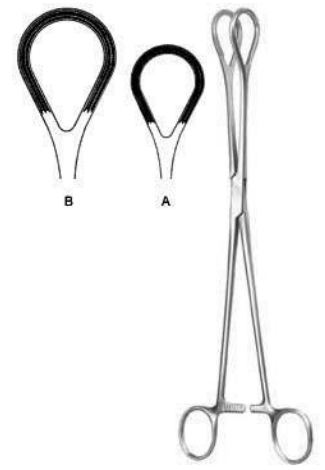

Grasping Forceps

II-5-606-25

Organ Grasping Forceps

Haemostatic Forceps



Collin

II-5-607-14

Organ Grasping Forceps

12.5 cm, 21 cm



Collin

II-5-608-17

Tumor Grasping Forceps

17 cm



Pennington

II-5-609-15

Haemostatic Forceps

15.5 cm



Pratt

II-5-610-15

Haemostatic Forceps

15 cm



Martel-Rees

II-5-611-14

Face-lift Forceps

13.5 cm



Ligature Forceps

II-5-612-12

Ligature Forceps

Haemostatic Forceps

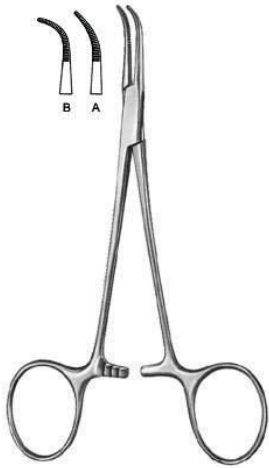

Mixer-Baby
II-5-613-01

Dissecting and Ligature Forceps

13 cm , 13.5 cm

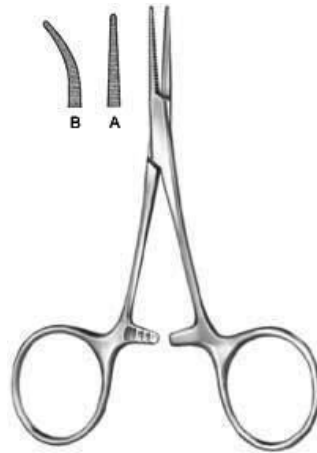

Hartmann
II-5-614-10

Haemostatic Forceps

9.5 cm, 10 cm



Ligature Forceps
II-5-615-12

Ligature Forceps

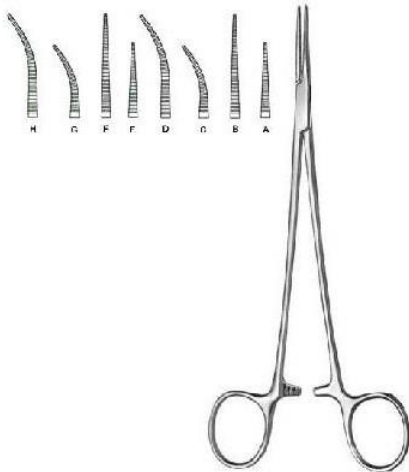

Halsted-Mosquito
II-5-616-18

Haemostatic Forceps

12.5 cm, 14 cm, 14.5 cm

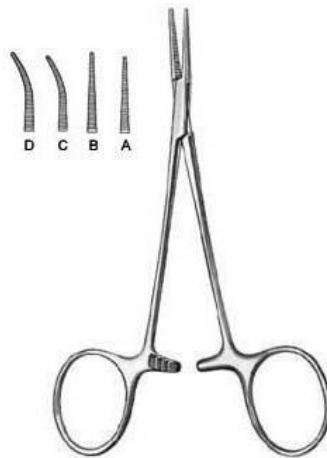

Mikro-Mosquito
II-5-617-10

Haemostatic Forceps

9.5 cm, 10 cm , 11.5 cm, 12 cm

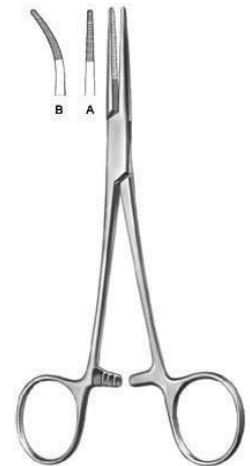

Providence-Hospital
II-5-618-14

Haemostatic Forceps

14 cm

Haemostatic Forceps



Leriche

II-5-619-15

Haemostatic Forceps

15 cm, 15.5 cm

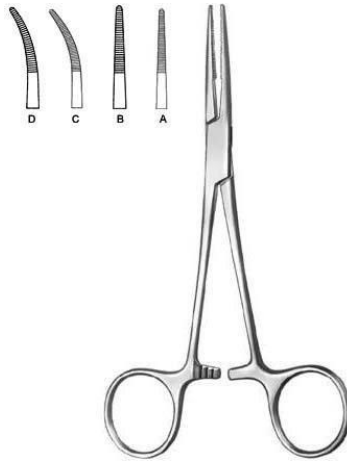

Kelly

II-5-620-14

Haemostatic Forceps

14 cm, 14.5 cm



Kelly-Rankin

II-5-621-16

Haemostatic Forceps

15.5 cm, 16 cm



Overholt-Baby

II-5-622-14

Dissecting and Ligature
Forceps 14 cm, 14.5 cm

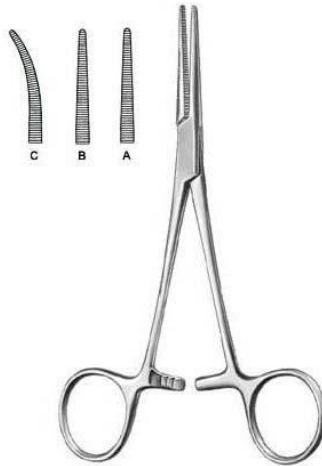

Crile

II-5-623-14

Haemostatic Forceps
14 cm, 14.5 cm



Crile-Rankin

II-5-624-16

Haemostatic Forceps
16 cm, 16.5 cm

Haemostatic Forceps

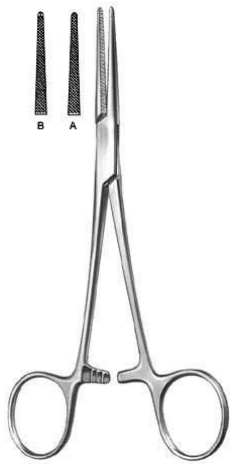

Lovelace

II-5-625-15

Haemostatic Forceps
16 cm



Dandy-Mosquito

II-5-626-12

Haemostatic Forceps
12 cm

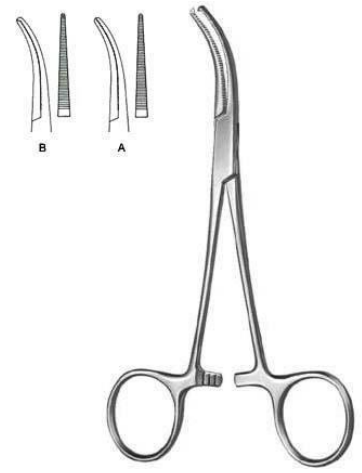

Dandy

II-5-627-14

Haemostatic Forceps
14 cm, 14.5 cm



Schmidt

II-5-628-18

Dissecting and Ligature Forceps
18.5 cm , 19 cm



Adson

II-5-629-18

Dissecting and Ligature Forceps
18.5 cm , 19 cm



Martin-Fuchsig

II-5-630-20

Dissecting and Ligature Forceps
20.5 cm

Haemostatic Forceps

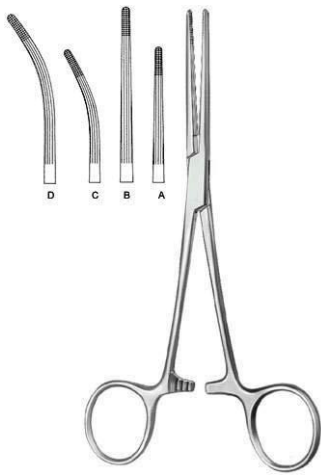

Rochester-Carmalt

II-5-631-16

Haemostatic Forceps
16.5 cm , 17 cm , 20 cm , 20.5 cm

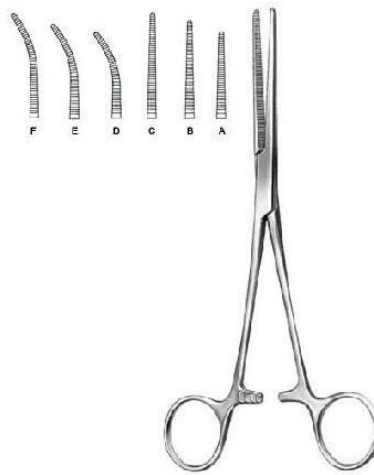

Pean

II-5-632-13

Haemostatic Forceps
13 cm , 13.5 cm , 14 cm , 14.5 cm , 16.5 cm ,
17 cm

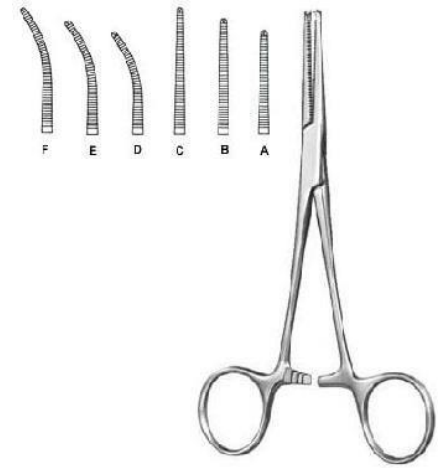

Kocher-Nippon

II-5-633-14

Haemostatic Forceps
14.5 cm , 16 cm , 16.5 cm , 18 cm , 18 cm

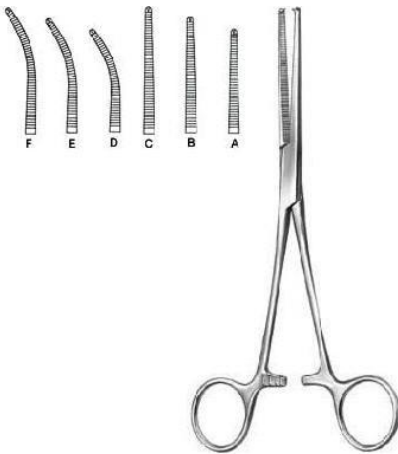

Kocher

II-5-635-13

Haemostatic Forceps
13 cm , 14 cm , 16 cm

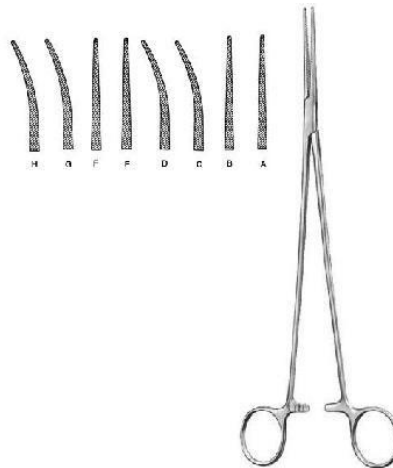

Bengolea

II-5-636-20

Haemostatic Forceps
21 cm , 21.5 cm , 26 cm

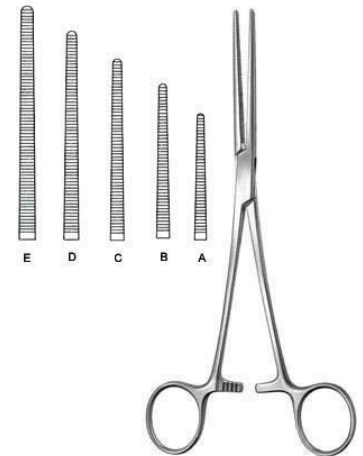

Pean (Rochester)

II-5-637-14

Haemostatic Forceps
14 cm , 14.5 cm , 16 cm , 16.5 cm , 18.5 cm ,
20.5 cm , 22.5 cm , 24.5 cm , 26 cm , 30.5 cm

Haemostatic Forceps

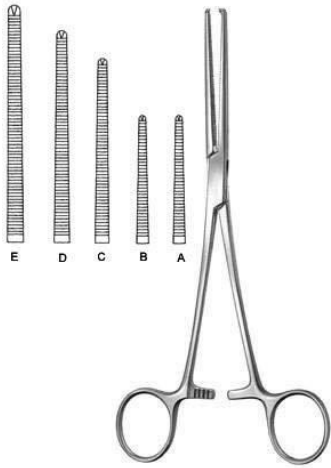

Kocher (Ochsner)

II-5-638-14

Haemostatic Forceps

14.5 cm , 16.5 cm, 18.5 cm , 20.5 cm, 22.5 cm, 24.5 cm, 26 cm, 30.5 cm

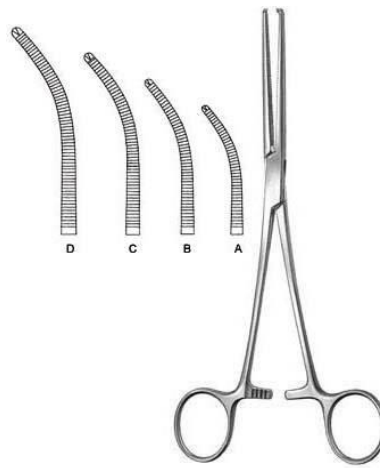

Kocher (Ochsner)

II-5-639-14

Haemostatic Forceps

14 cm, 16 cm, 18 cm, 20 cm, 22 cm, 24 cm , 25.5 cm, 30 cm

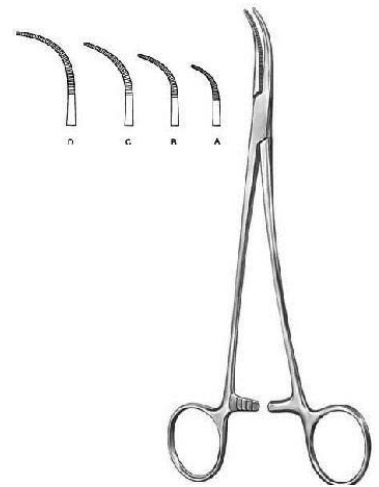

Overholt-Martin

II-5-640-01

Dissecting and Ligature Forceps

18.5 cm Fig. 1 , 20.5 cm Fig. 2, 21 cm Fig. 3, 21.5 cm Fig. 4, 24.5 cm Fig. 5



Mixer-Baby

II-5-641-18

Dissecting and Ligature Forceps

18.5 cm



Adson-Baby

II-5-642-14

Dissecting and Ligature Forceps

14.5 cm , 18 cm



Heiss

II-5-643-20

Dissecting and Ligature Forceps

20 cm, 20.5 cm, 21 cm

Haemostatic Forceps



Overholt-Mixer

II-5-644-21

Dissecting and Ligature Forceps
21.5 cm

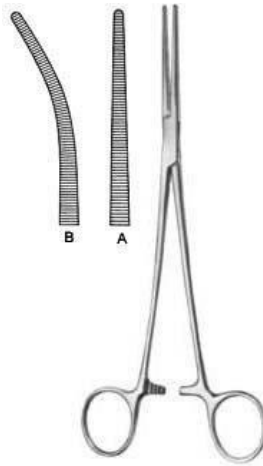

Roberts

II-5-645-22

Dissecting and Ligature Forceps
21.5 cm, 22.5 cm

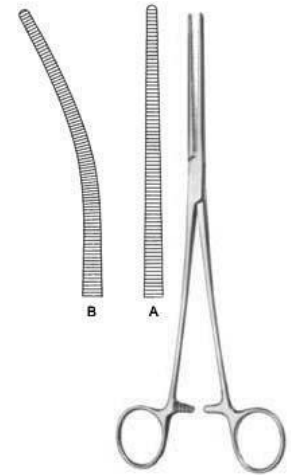

Sarot

II-5-646-24

Dissecting and Ligature Forceps
24.5 cm, 25 cm

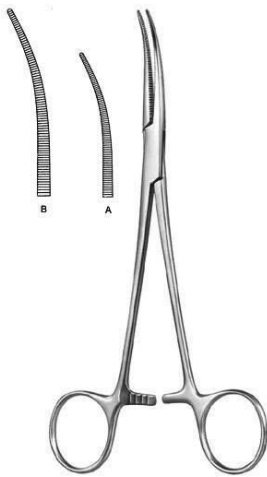

Crafoord

II-647-18

Dissecting and Ligature Forceps
18 cm, 24.5 cm

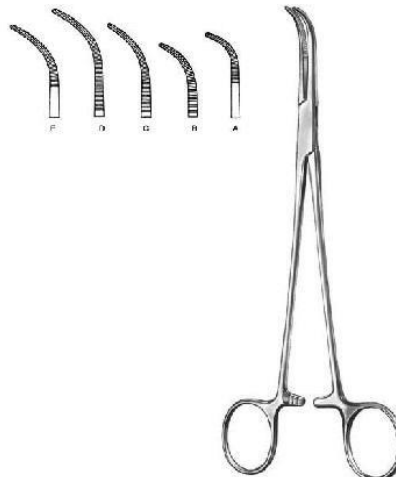

Overholt-Geissendorfer

II-5-648-01

Dissecting and Ligature Forceps
20.5 cm Fig. 1 , 20 cm Fig. 2 , 21.5 cm Fig. 3 , 22 cm Fig. 4, 21.5 cm Fig. 5, 22 cm Fig. 6 , 27 cm Fig. 1 , 26.5 cm Fig. 2 , 27.5 cm Fig. 3 , 28 cm Fig. 4

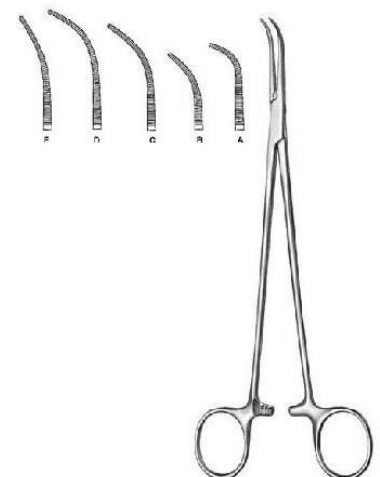

Overholt-Fino

II-5-649-00

Dissecting and Ligature Forceps
21 cm, 21.5 cm, 22 cm, 22.5 cm, 23 cm

Haemostatic Forceps

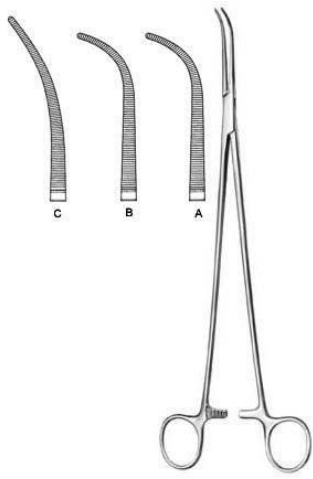

Overholt
II-5-650-00

Dissecting and Ligature Forceps
29.5 cm, 30 cm



Overholt-Mini
II-5-651-01

Dissecting and Ligature Forceps
15 cm, 20 cm

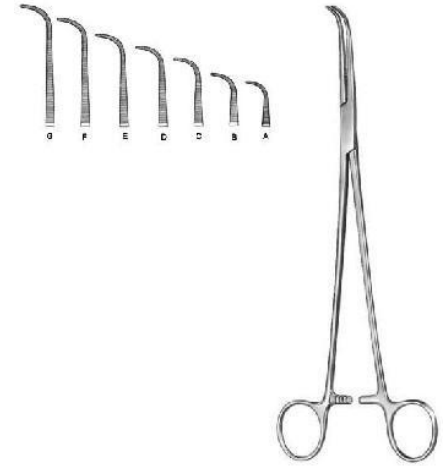

Gemini
II-5-652-13

Dissecting and Ligature Forceps
13 cm , 16 cm, 18 cm, 21 cm , 23 cm , 25 cm , 28 cm

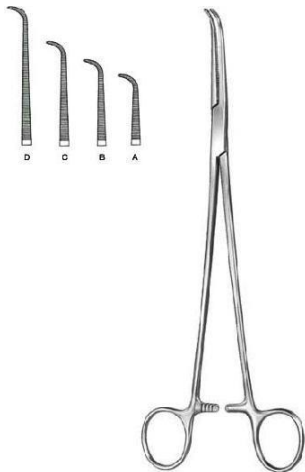

Mini-Gemini
II-5-653-18

Dissecting and Ligature Forceps
18 cm, 22.5 cm, 25 cm , 28.5 cm

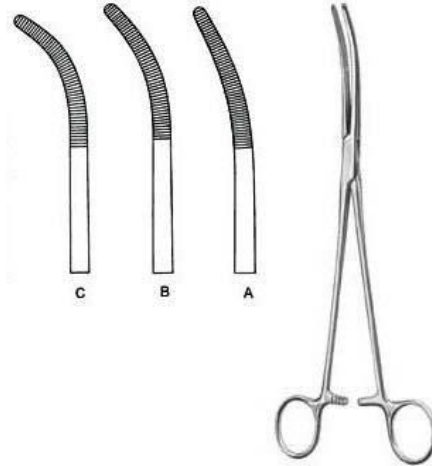

Rumel
II-5-654-01

Dissecting and Ligature Forceps
24 cm Fig. 1 , 23.5 cm Fig. 2 , 23 cm Fig. 3,
24 cm Fig. 4 , 23.5 cm Fig. 5

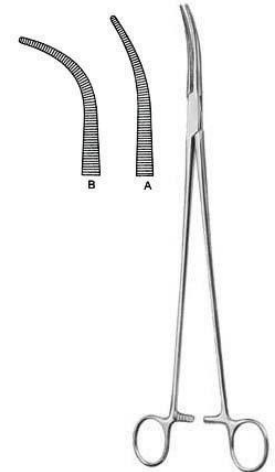

Zenker
II-5-655-01

Dissecting and Ligature Forceps
28.5 cm, 29.5 cm

Haemostatic Forceps



Mixer-Baby
II-5-656-14

Dissecting and Ligature Forceps
13.5 cm

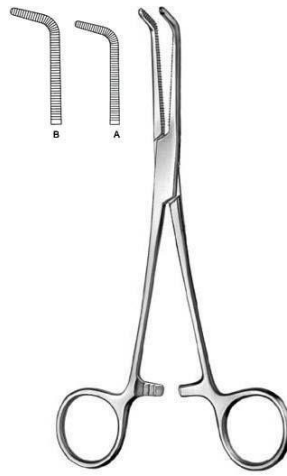

Mixer
II-5-657-15

Dissecting and Ligature Forceps
16 cm, 18 cm



Mixer-O Shaugnessy
II-5-658-19

Dissecting and Ligature Forceps
18 cm



Mixer
II-5-659-22

Dissecting and Ligature Forceps
22.5 cm



Mixer
II-5-660-23

Dissecting and Ligature Forceps
23 cm

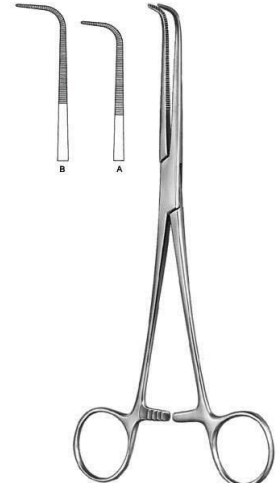

Wickstrom
II-5-661-21

Dissecting and Ligature Forceps
21 cm, 24.5 cm

Haemostatic Forceps

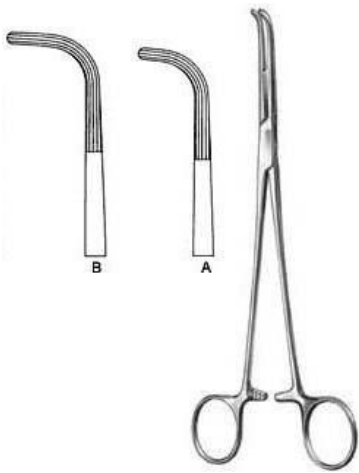

Mixer

II-5-662-22

Dissecting and Ligature Forceps
22.5 cm, 26 cm, 28 cm



Mc Quigg-Mixer

II-5-663-22

Dissecting and Ligature Forceps
23.5 cm



Lower

II-5-664-18

Dissecting and Ligature Forceps
18.5 cm



Lahey

II-5-665-19

Bile Duct Clamp
19.5 cm, 22.5 cm



Finochietto

II-5-666-24

Dissecting and Ligature Forceps
24 cm



Uro-Tangential

II-5-667-01

Tangential Forceps
25 cm, 27 cm

Haemostatic Forceps

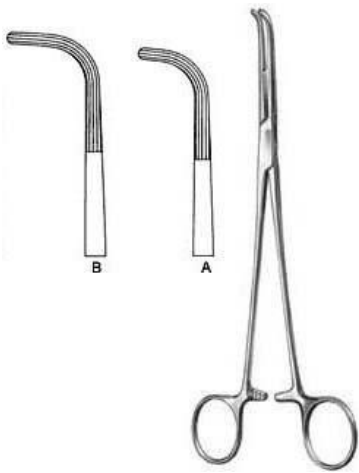

Mixer

II-5-662-22

Dissecting and Ligature Forceps
22.5 cm, 26 cm, 28 cm



Mc Quigg-Mixer

II-5-663-22

Dissecting and Ligature Forceps
23.5 cm



Lower

II-5-664-18

Dissecting and Ligature Forceps
18.5 cm



Lahey

II-5-665-19

Bile Duct Clamp
19.5 cm, 22.5 cm



Finochietto

II-5-666-24

Dissecting and Ligature Forceps
24 cm



Uro-Tangential

II-5-667-01

Tangential Forceps
25 cm, 27 cm

Haemostatic Forceps

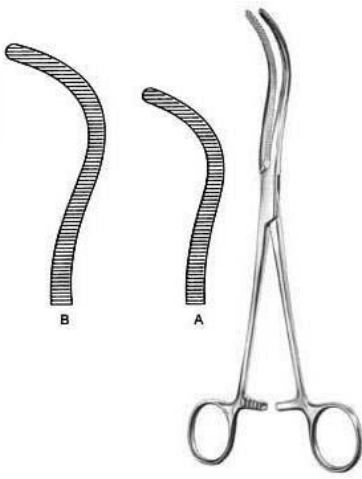

Guyon

II-5-668-20

Kidney Pedicle Clamp
23 cm , 24 cm



Guyon

II-5-669-23

Kidney Pedicle Clamp
19.5 cm , 21.5 cm, 24 cm



Desjardins

II-5-670-21

Bile Duct Clamp
21 cm

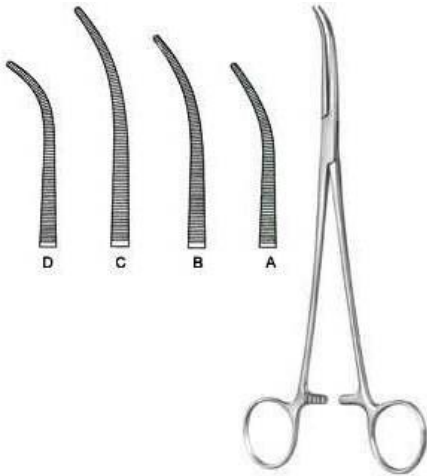

Kelly

II-5-671-19

Dissecting and Ligature Forceps
19.5 cm Fig. 1 , 22.5 cm Fig. 1 , 24.5 cm
Fig. 1 , 19 cm Fig. 2 , 22 cm Fig. 2 , 24 cm
Fig. 2 , 18.5 cm Fig. 3 , 23.5 cm Fig. 3, 21.5
cm Fig. 3



Lawrence

II-5-672-28

Dissecting and Ligature Forceps
28 cm



Meeker

II-5-673-28

Dissecting and Ligature Forceps
28 cm



Negus

II-5-674-19

Haemostatic Forceps
19.5 cm Fig. 1 , 20 cm Fig. 2

Towel & Tubing Clamps



Schaedel

II-5-701-09

Towel Clamp sharp
9 cm



Jones

II-5-702-05

Towel Clamp sharp
5.5 cm, 8.5 cm



Jones-Martin

II-5-703-09

Towel Clamp sharp
8.5 cm



Backhaus

II-5-705-11

Towel Clamp
11.5 cm



Backhaus

II-5-706-08

Towel Clamp
9 cm, 11.5 cm, 13 cm , 16 cm



Peers-Bertram Modif.

II-5-707-15

Towel Clamp wide jaw for tube fixation
15.5 cm

Towel & Tubing Clamps



R?Der
II-5-708-13

Towel Clamp
13.5 cm

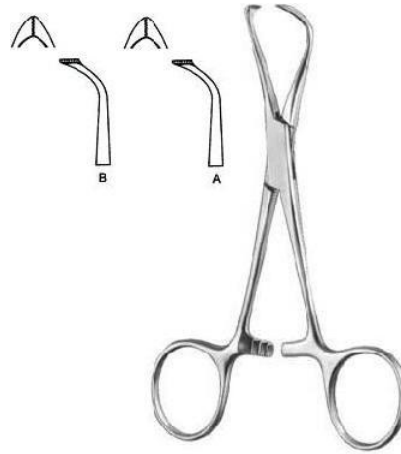

Lorna
II-5-709-10

Towel Clamp fine serrated, wide jaw
9.5 cm, 13 cm



Bernhard
II-5-710-16

Towel Clamp
16.5 cm

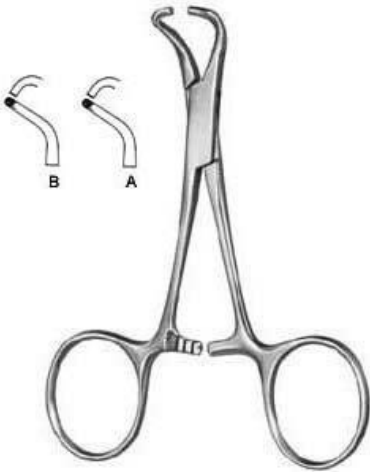

Tohoku
II-5-711-10

Towel Clamp
10.5 cm blunt, 13.5 cm blunt, 14.5 cm

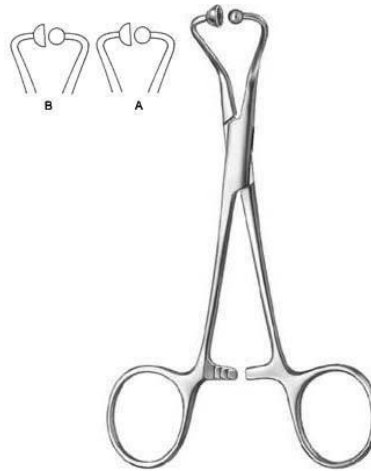

Towel Clamp For Paper Clothes
II-5-712-11

Towel Clamp for paper clothes
11.5 cm, 14 cm



Lane
II-5-713-20

Lane
19.5 cm

Towel & Tubing Clamps



Tube Holder For Fixation Of Six Tubes

II-5-714-06

Tube Holder for fixation of six tubes



Tubing Clamp Extra Long Ratchet

II-5-715-14

Tubing Clamp extra long ratchet
14 cm



Tubing Clamp

II-5-716-16

Tubing Clamp
16.5 cm

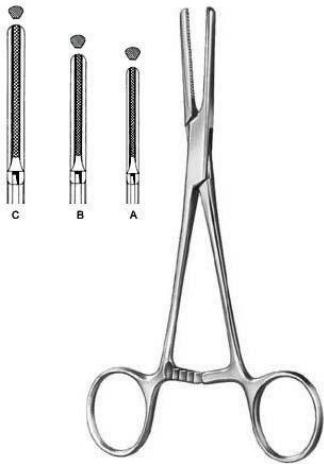

Tubing Clamp

II-5-717-15

Tubing Clamp
15.5 cm, 19 cm , 20.5 cm

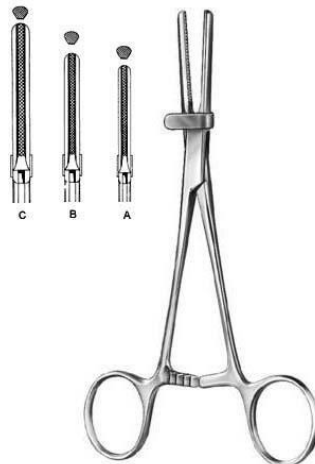

Tubing Clamp With Safety Guard

II-5-718-15

Tubing Clamp with safety guard
15.5 cm, 19 cm , 20.5 cm

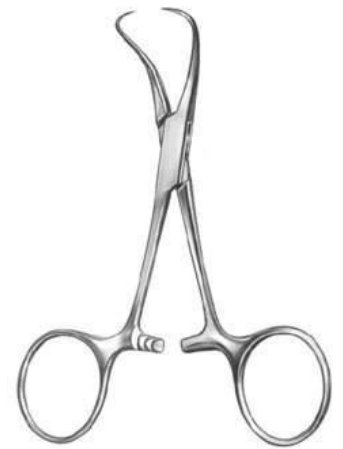

Backhaus

II-5-704-11

Towel Clamp
11.5 cm, 13 cm

Dressing & Sponge Forceps

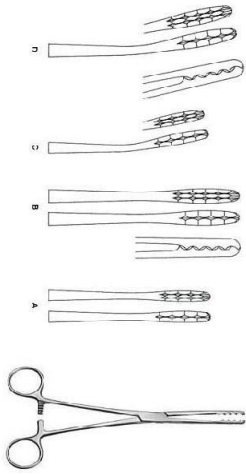

Ulrich

II-5-801-22

Dressing Forceps
21.5 cm, 26.5 cm

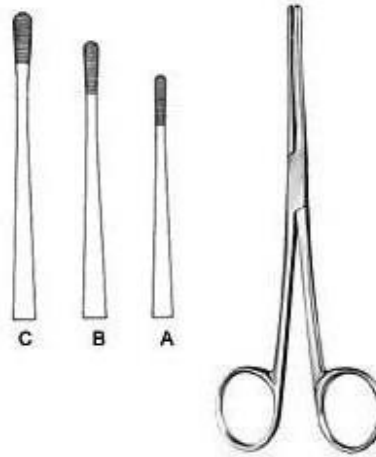

Lister

II-5-802-13

Sinus Forceps
13 cm, 16 cm, 18 cm



Martin

II-5-803-17

Dressing Forceps
17.5 cm, 17 cm

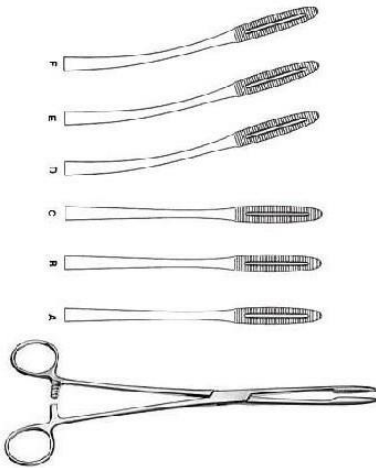

Gross-Maier

II-5-804-20

Dressing Forceps
20.5 cm, 22 cm, 26.5 cm, 20 cm, 21.5 cm,
26 cm



Tunneling Forceps

II-5-805-40

Tunneling Forceps
39.5 cm



Collin

II-5-806-25

Dressing Forceps
25.5 cm

Dressing & Sponge Forceps



Cheron

II-5-807-25

Dressing Forceps
23.5 cm



Bozemann

II-5-808-26

Sponge Forceps
26 cm

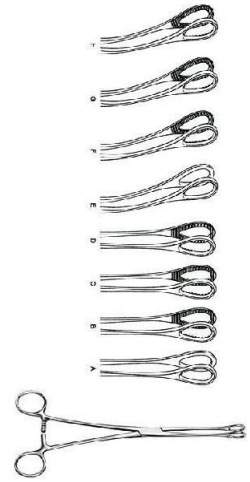

Foerster

II-5-809-25

Sponge Forceps
25 cm , 18 cm, 20.5 cm, 24.5 cm, 17.5 cm,
20 cm, 24.5 cm

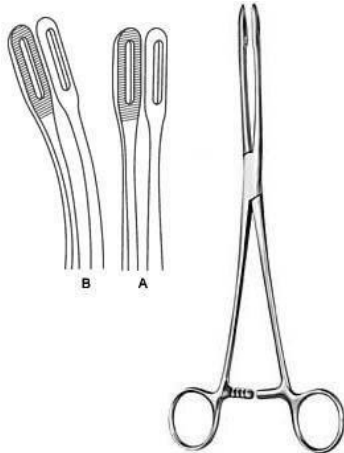

Foerster

II-5-810-25

Sponge Forceps
25 cm , 24.5 cm

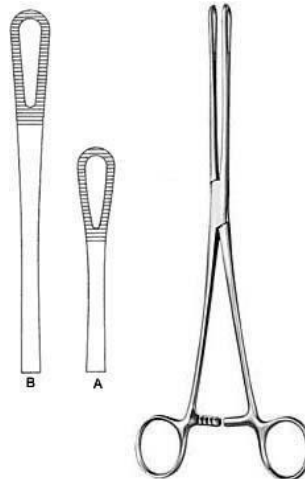

Rampley

II-5-811-18

Sponge Forceps
18.5 cm , 24.5 cm

Retractors



Vickers
II-5-901-18
 Skin Hooklet
 18.5 cm



Vickers
II-5-902-01
 Bone Hooklet
 17 cm



Vickers
II-5-903-01
 Tendon Hooklet
 17 cm

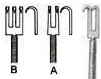

Vickers
II-5-904-02
 Hooklet
 16 cm

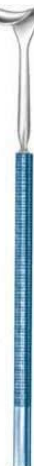
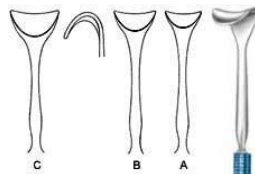

Vickers
II-5-905-12
 Saddle Hook
 14 cm



Graefe
II-5-906-01
 Micro Hooklet
 15 cm

Retractors

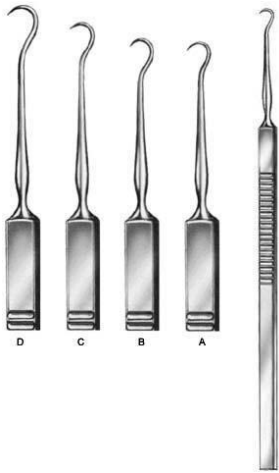

Skin Hook

II-5-907-01

Skin Hook

16 cm Fig. 1, 16 cm Fig. 2, 16 cm Fig. 3, 16 cm Fig. 4



O Connor

II-5-908-16

Skin Hook

16 cm

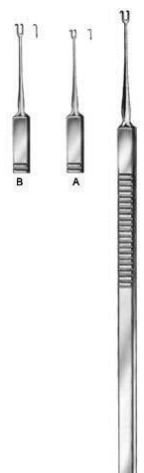

Guthrie

II-5-909-01

Skin Hook

15.5 cm

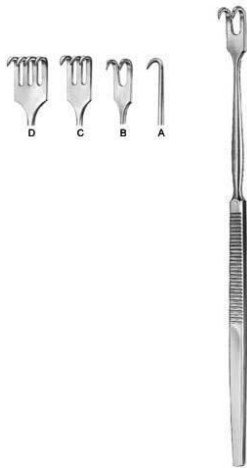

Hooklet

II-5-910-01

Hooklet

16.5 cm



Hooklet

II-5-911-01

Hooklet

16.5 cm

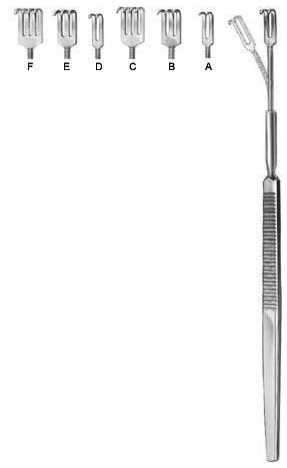

Hooklet

II-5-912-02

Hooklet

16 cm

Retractors



Hooklet
II-5-913-04
 Hooklet
 16.5 cm



Vessel Hook
II-5-914-12
 Vessel Hook
 12 cm

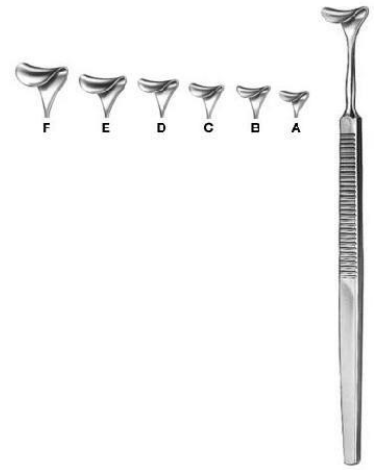

Desmarres
II-5-915-08
 Saddle Hook
 16 cm 8 mm, 16 cm 10 mm, 16 cm 12 mm,
 16 cm 14 mm, 16 cm 16 mm, 16 cm 18 mm

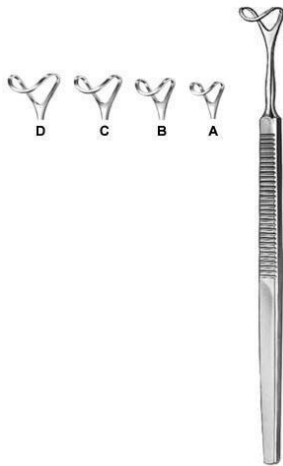

Saddle Hook
II-5-916-12
 Saddle Hook
 16 cm 12 mm, 16 cm 14 mm, 16 cm 16
 mm, 16 cm 18 mm

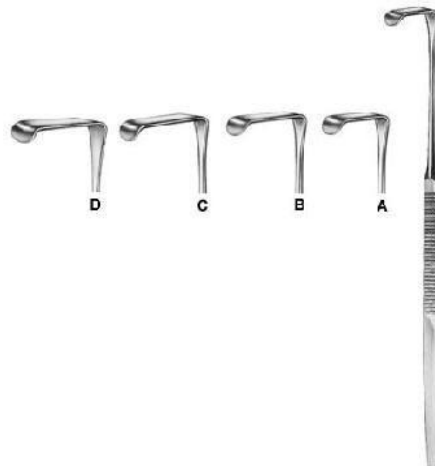

Langenbeck-Mini
II-5-917-10
 Langenbeck-Mini
 16 cm



Hooklet
II-5-918-16
 Hooklet
 16 cm 14 x 8

Retractors



Hooklet

II-5-919-01

Hooklet
16.5 cm



Hooklet

II-5-920-01

Hooklet
16.5 cm



Meyerding

II-5-921-01

Hooklet
17.5 cm Fig. 1, 17.5 cm Fig. 2, 17.5 cm Fig. 3, 17.5 cm Fig. 4, 17.5 cm Fig. 5, 17.5 cm Fig. 6



Senn-Green

II-5-922-01

Hooklet
15 cm Fig. 1, 15 cm Fig. 2



Ragnell-Davis

II-5-923-14

Hooklet
14 cm

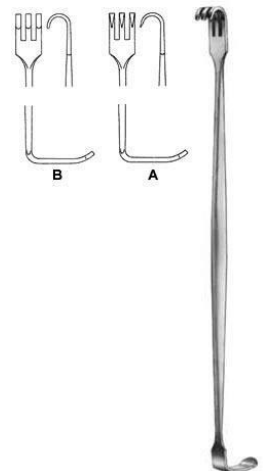

Senn-Miller

II-5-924-16

Hooklet
16 cm

Retractors



Cushing
II-5-925-20

Cushing
20.5 cm

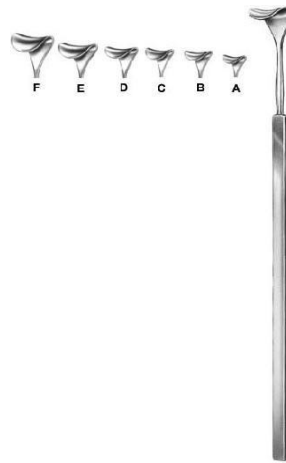

Cushing
II-5-926-08

Saddle Hook
20.5 cm 8 mm wide , 20.5 cm 10 mm wide,
20.5 cm 12 mm wide, 20.5 cm 14 mm wide,
20.5 cm 16 mm wide, 20.5 cm 18 mm wide



Cushing
II-5-927-08

Saddle Hook 8 mm to 18 mm wide
24 cm



Brom
II-5-928-01

Vein Hook
19.5 cm



Strandell-Stille
II-5-929-01

Strandell-Stille
19 cm Fig. 1, 19 cm Fig. 2

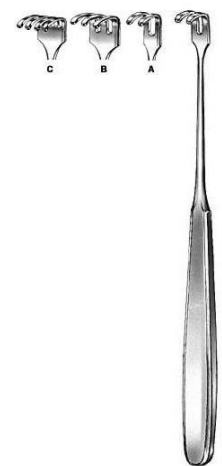

Klapp
II-5-930-01
Retractor 12 x 6, 12 x 11, 15 x 11
17.5 cm

Retractors



Hooklet
II-5-931-04
 Hooklet
 16.5 cm

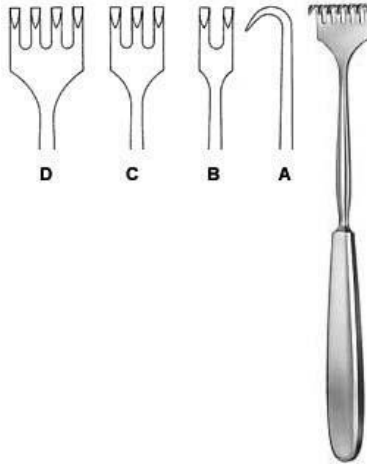

Volkmann
II-5-932-01
 Retractor
 21.5 cm

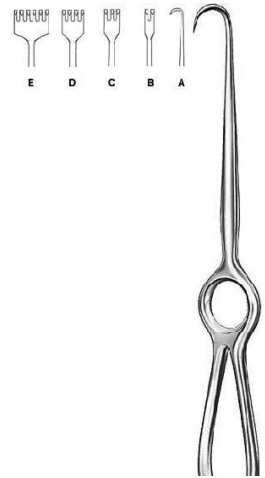

Volkmann
II-5-933-01
 Retractor
 22 cm, 21.5 cm

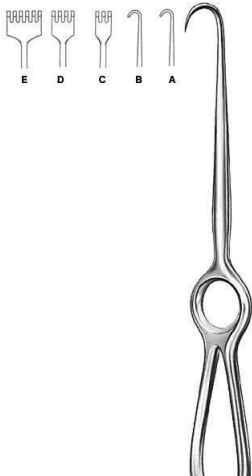

Kocher
II-5-934-01
 Retractor
 22 cm

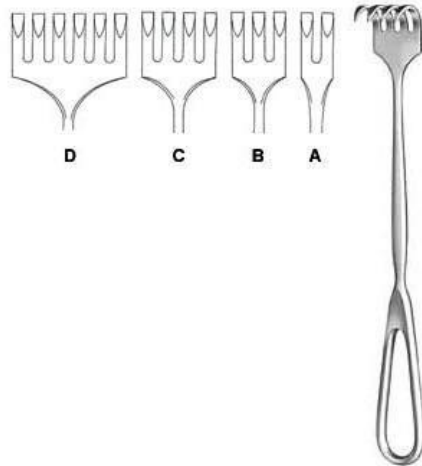

Martin
II-5-935-02
 Retractor
 22.5 cm

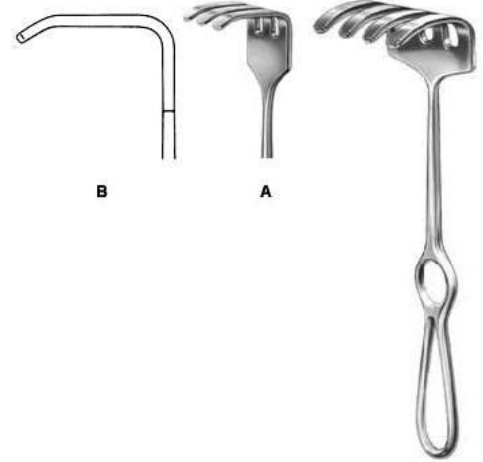

Ollier
II-5-936-03
 Retractor
 23 cm 36 x 30, 23 cm 36 x 60

Retractors

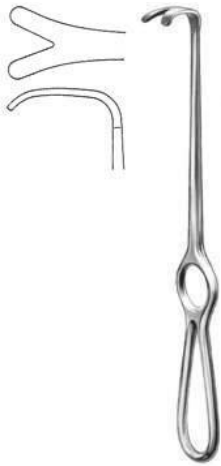

Wassmund

II-5-937-02

Retractor
20.5 cm 33 x 21

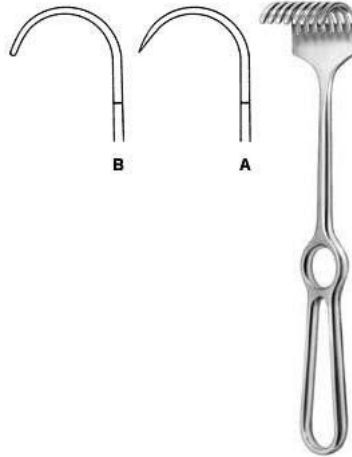

Korte

II-5-938-08

Retractor
24.5 cm 40 x 30

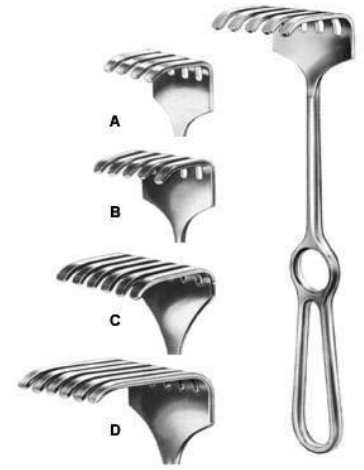

Israel

II-5-939-04

Retractor
25.5 cm

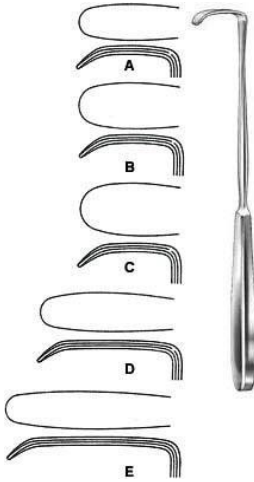

Langenbeck

II-5-940-01

Retractor
22.5 cm 30 x 11 mm, 22.5 cm 30 x 14 mm,
22.5 cm 30 x 16 mm, 22.5 cm 40 x 11 mm,
22.5 cm 50 x 11 mm

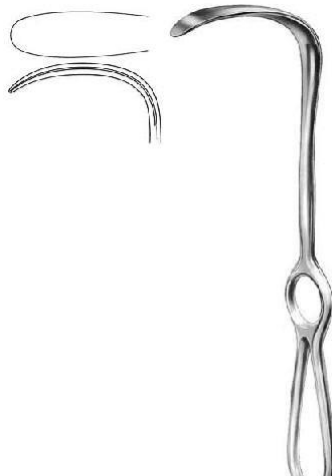

Langenbeck

II-5-942-21

Retractor
21 cm 65 x 20 mm



Langenbeck

II-5-943-21

Retractor
22.5 cm 85 x 15 mm

Retractors



Lahey

II-5-944-19

Retractor

19.5 cm 36 x 19 mm



Little

II-5-945-20

Retractor

20 cm 13 x 15 mm



Kocher

II-5-946-18

Retractor

23 cm 43 x 18 mm, 23 cm 53 x 20 mm, 23 cm 63 x 25 mm, 23 cm 77 x 30 mm, 23 cm 78 x 40 mm

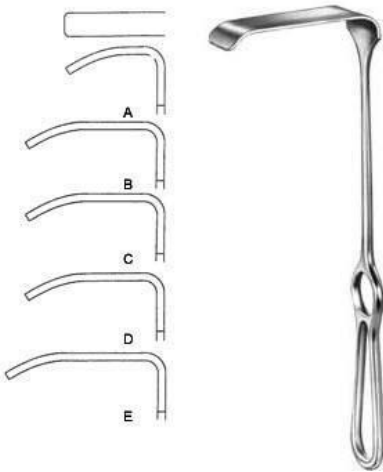

Kocher-Langenbeck

II-5-947-01

Retractor

21.5 cm 25 x 6 mm, 21.5 cm 35 x 8 mm, 21.5 cm 35 x 11 mm, 21.5 cm 35 x 15 mm, 21.5 cm 40 x 11 mm, 21.5 cm 55 x 11 mm, 21.5 cm 70 x 14 mm, 21.5 cm 80 x 12 mm

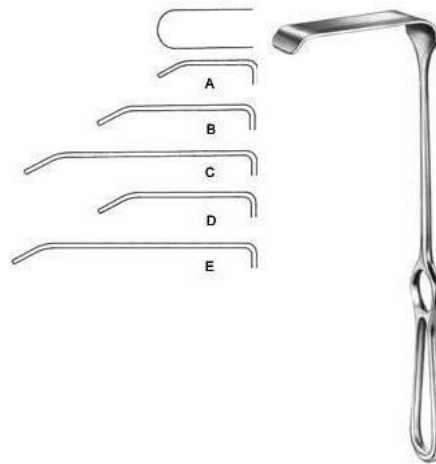

Kocher-Langenbeck

II-5-948-01

Retractor

21.5 cm 25 x 10 mm, 21.5 cm 40 x 13 mm, 21.5 cm 60 x 13 mm, 21.5 cm 40 x 18 mm, 21.5 cm 60 x 18 mm, 21.5 cm 85 x 18 mm, 21.5 cm 60 x 25 mm, 21.5 cm 85 x 25 mm

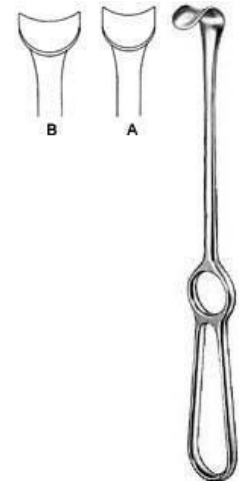

Kocher

II-5-949-01

Retractor

21.5 cm 22 x 12, 21.5 cm 24 x 14 mm

Retractors

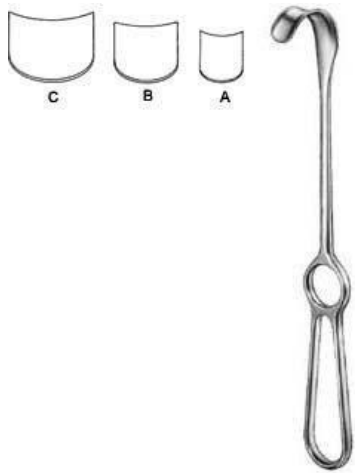

Kocher

II-5-950-01

Retractor

22 cm 42 x 10 mm, 22 cm 42 x 15 mm, 22 cm 43 x 20 mm

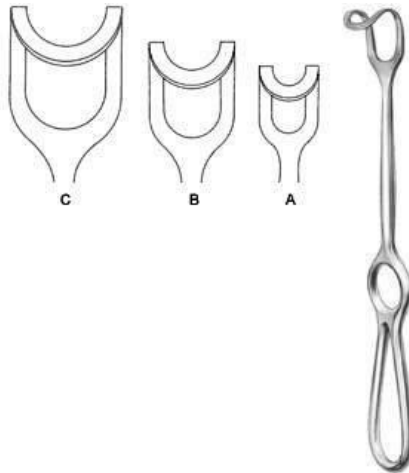

Middeldorpf

II-5-951-01

Retractor

21.5 cm 18 x 17 mm, 23 cm 25 x 22 mm, 24.5 cm 30 x 31 mm



Doyen-Stillé

II-5-952-01

Retractor

26 cm 97 x 29 mm, 26 cm 101 x 31 mm, 26 cm 127 x 52 mm

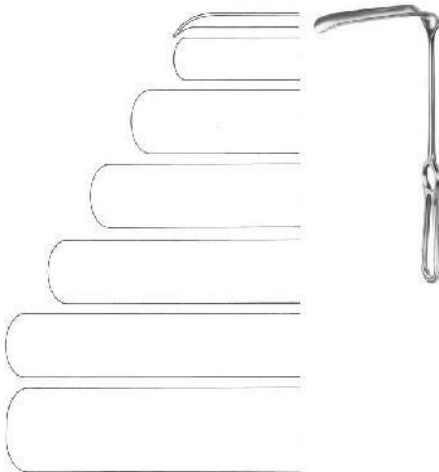

Hosel

II-5-953-01

Retractor

26 cm 63 x 21 mm, 26 cm 83 x 30 mm, 26 cm 103 x 30 mm, 26 cm 120 x 30 mm, 26 cm 140 x 30 mm, 26 cm 140 x 40 mm

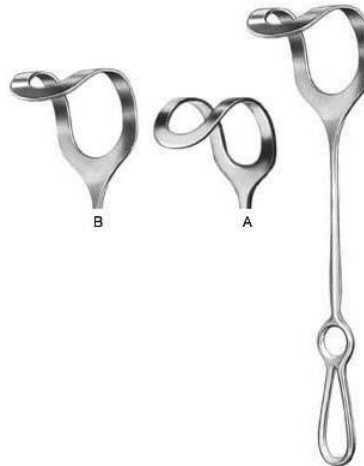

Middeldorpf

II-5-954-01

Retractor

27 cm 48 x 45 mm, 27 cm 52 x 50 mm, 27 cm 60 x 70 mm

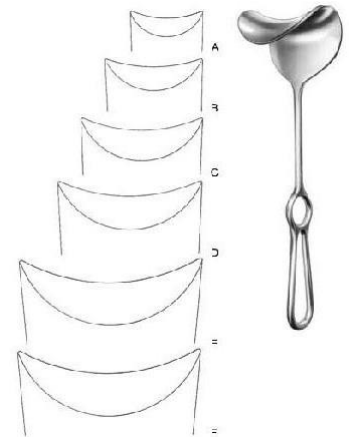

Fritsch

II-5-955-00

Retractor

23.5 cm 37 x 31 mm, 24 cm 38 x 40 mm, 25 cm 43 x 51 mm, 25 cm 49 x 61 mm, 25.5 cm 48 x 75 mm, 25.5 cm 65 x 85 mm

Retractors



Doyen

II-5-956-25

Retractor
24 cm 48 x 88 mm



Kocher

II-5-957-22

Retractor
24 cm 73 x 25 mm



Kocher

II-5-958-01

Retractor
25 cm 80 x 45 mm, 25 cm 80 x 55 mm, 25 cm 80 x 65 mm



Martin

II-5-959-25

Retractor
26 cm 110 x 27 mm

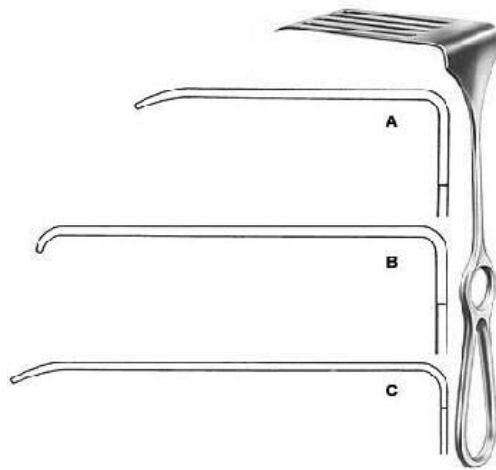

Coryllos

II-5-960-01

Retractor
24 cm 85 x 22 mm, 24 cm 108 x 43 mm, 24 cm 119 x 65 mm



Davidson

II-5-961-01

Retractor
19 cm 80 x 54 mm, 18.5 cm 80 x 95 mm

Retractors

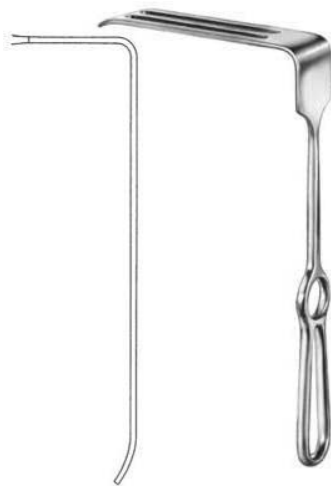

Sauerbruch

II-5-962-25

Retractor

25.5 cm 127 x 38 mm

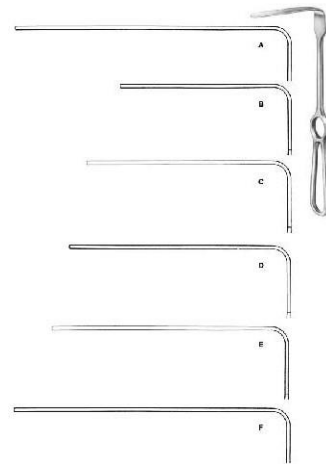

Brunner

II-5-963-08

Retractor

25.5 cm 84 x 20 mm, 25.5 cm 104 x 25 mm,
25.5 cm 124 x 30 mm, 25.5 cm 130 x 30
mm, 25.5 cm 144 x 30 mm, 25.5 cm 160 x
30 mm, 25.5 cm 164 x 30 mm

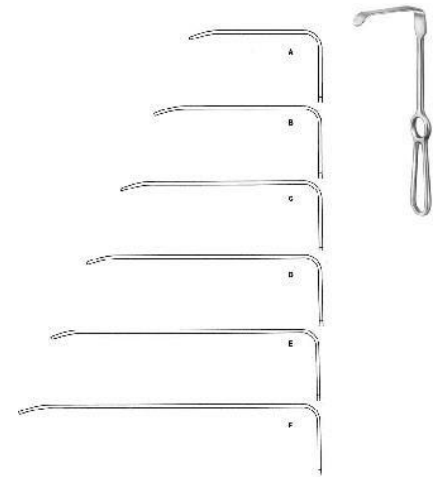

Brunner

II-5-964-08

Retractor

25.5 cm 82 x 20 mm, 25.5 cm 102 x 20 mm,
25.5 cm 122 x 25 mm, 25.5 cm 140 x 25
mm, 25.5 cm 162 x 30 mm, 25.5 cm 182 x
30 mm

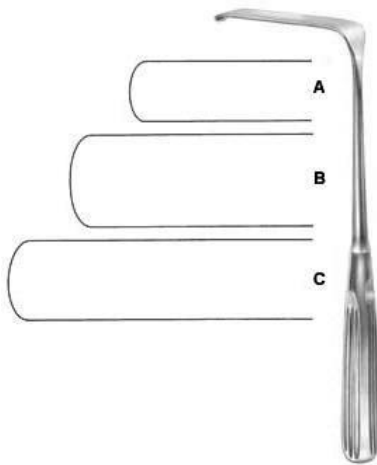

Sauerbruch

II-5-965-01

Retractor

22.5 cm 50 x 15 mm, 22.5 cm 63 x 23 mm,
22.5 cm 80 x 20 mm



Deaver

II-5-966-01

Retractor

18 cm 19 mm

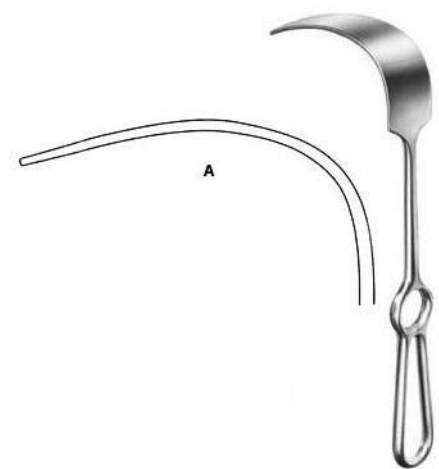

Mikulicz

II-5-968-01

Retractor

25 cm 90 x 35 mm, 25 cm 125 x 50 mm, 25
cm 160 x 50 mm

Retractors



Mikulicz

II-5-969-26

Retractor

26 cm 90 x 55 mm

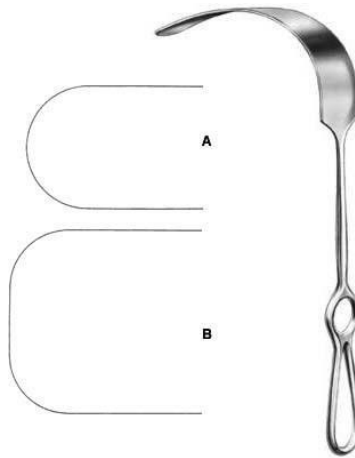

Kelly

II-5-970-01

Retractor

27.5 cm 205 x 38 mm, 27.5 cm 205 x 57 mm



Farabeuf

II-5-971-00

Retractor

15 cm Fig. 1 = 23 x 16, 15 cm Fig. 1 = 26 x 16, 15 cm Fig. 2 = 27 x 16, 15 cm Fig. 2 = 30 x 16

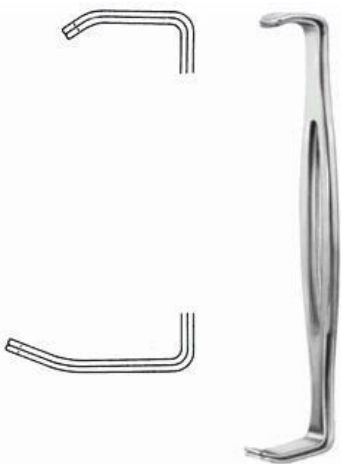

Parker-Langenbeck

II-5-972-00

Retractor

21.5 cm Fig. 1 = 21x15 mm, 21.5 cm Fig. 1 = 40x15 mm, 21.5 cm Fig. 2 = 25x15 mm, 21.5 cm Fig. 2 = 45x15 mm



Alm

II-5-973-07

Wound Spreaders, self-retaining

7 cm



Alm

II-5-974-07

Wound Spreaders, self-retaining

7 cm

Retractors



Gosset

II-5-975-22

Abdominal Retractor
18.5 cm



Balfour-Baby

II-5-976-00

Abdominal Retractor spreading 90mm, 1
central blade 24 x 20 mm
12.5 cm



Balfour

II-5-977-00

Abdominal retractor spreading 180 mm,
lateral blades 70 x 35 mm, 1 central blade
20 cm

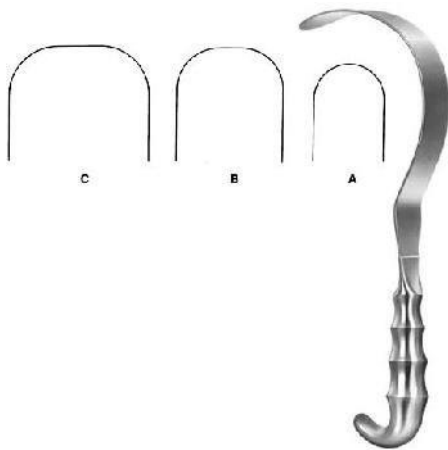

Deaver

II-5-967-04

Retractor

31.5 cm 25 mm, 31.5 cm 38 mm, 31.5 cm
50 mm, 31.5 cm 100 mm

Probes



Probe

II-5-1001-11

Probe

11.5cm, 13 cm , 14.5 cm , 16 cm, 18 cm, 20cm, 25 cm , 30 cm



Probe

II-5-1002-11

Probe

11.5 cm, 13 cm , 14.5 cm , 16 cm, 18 cm, 20cm, 25 cm , 30 cm

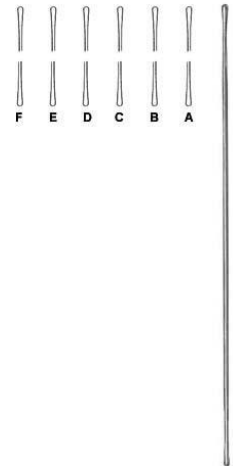

Probe

II-5-1003-13

Probe

13 cm , 14.5 cm , 16 cm, 18 cm, 20 cm, 25 cm



Probe With Eye

II-5-1004-13

Probe with eye

13 cm , 14.5 cm , 16 cm

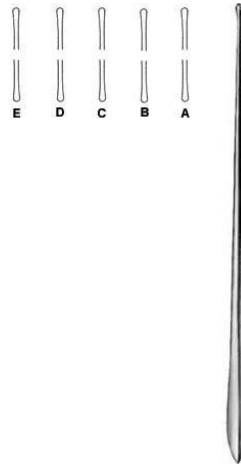

Myrtle Leaf Probe

II-5-1006-13

Myrtle Leaf Probe

13 cm , 14.5 cm , 16 cm, 18 cm, 20 cm



Grooved Director

II-5-1007-13

Grooved Director

13 cm , 14 cm, 16 cm

Probes



Grooved Director
II-5-1008-13
 Grooved Director
 13 cm , 14.5 cm , 16 cm



Doyen
II-5-1009-14
 Grooved Director
 14.5 cm



Nelaton
II-5-1010-16
 Grooved Director
 16 cm

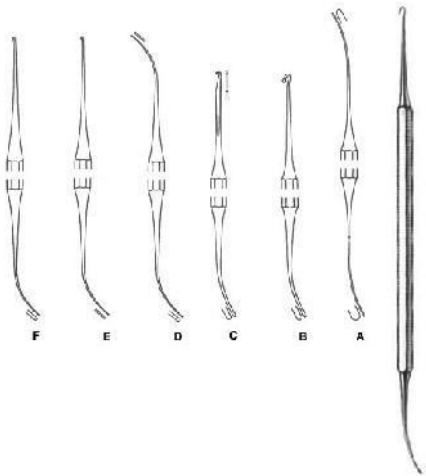

Varady
II-5-1011-01
 Phlebodissector
 18 cm, 17.5 cm

Plaster

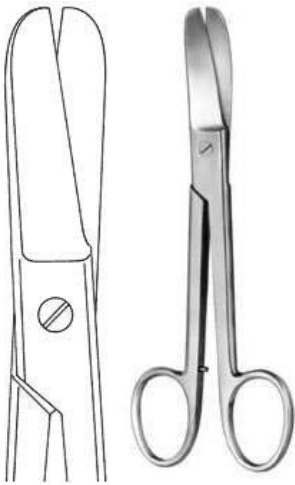

Lorenz

II-6-101-23

Bandage Scissors heavy pattern
23 cm



Lister

II-6-102-14

Bandage Scissors
14.5 cm , 18.5 cm , 20 cm



Bergmann

II-6-103-23

Plaster Shears
23.5 cm



Esmarch

II-6-104-20

Plaster Shears heavy pattern, short blades
20 cm



Bandage Scissors Black Plastic Ring With Autodavable

II-6-105-15

Bandage Scissors black plastic ring with autodavable
16 cm, 19 cm



Bandage Scissors Black Plastic Rings

II-6-106-18

Bandage Scissors black plastic rings
16 cm, 19 cm

Plaster

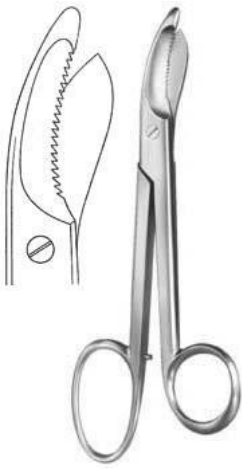

Brun's

II-6-107-24

Plaster Scissors
24 cm

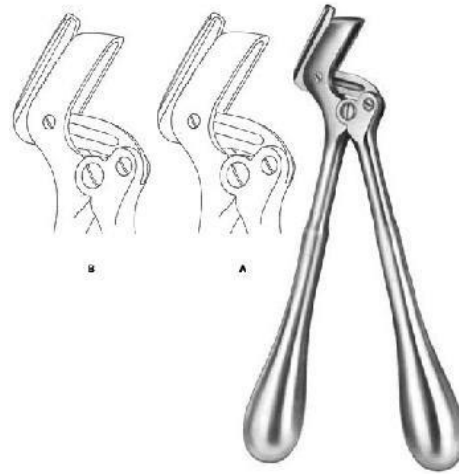

Stille-Martin

II-6-108-23

Plaster Shears
23 cm , 27 cm, 38 cm

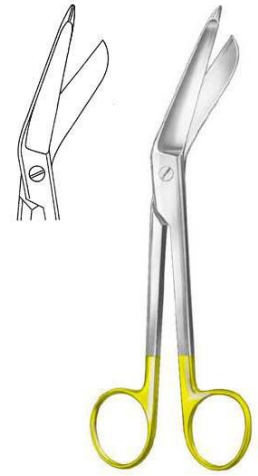

Lister

II-6-109-18

Bandage Scissors
18 cm

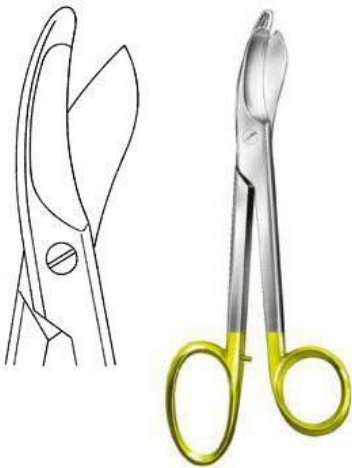

Brun's

II-6-110-24

Plaster Scissors
24 cm



Hopkins

II-6-111-20

Plaster Knife with wooden handle
20 cm



Reiner

II-6-112-18

Plaster Knife
18 cm

Plaster



Reiner

II-6-113-18

Plaster Knife
18 cm



Martin

II-6-114-21

Plaster Knife with wooden handle
21 cm



Engel

II-6-115-14

Plaster Saw
15.5 cm

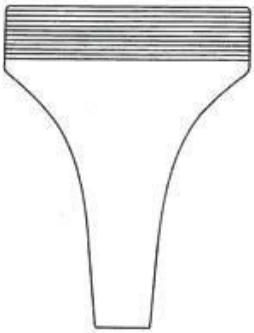

Hennig

II-6-116-28

Plaster Spreader
28 cm



Wolff

II-6-117-18

Plaster Breaker
18 cm, 26.5 cm

Neurosurgery



Gigli

II-8-101-01

Wire Saw Handle



De Martel

II-8-102-33

Wire Saw Guide
33 cm



Crutchfield

II-8-103-01

Skull Traction Tong small pattern



Skull Traction Tong Large Pattern

II-8-104-01

Skull Traction Tong large pattern
22.5 cm



Dahlgren

II-8-105-20

Cranial Rongeur
20 cm



Olivecrona-Toennis

II-8-106-14

Clip Applying Forceps

Neurosurgery



McKenzie

II-8-107-19

Clip Applying Forceps
18.5 cm



Olivecrona

II-8-108-18

Dura Dissector
18 cm



Olivecrona

II-8-109-19

Dura Dissector
20 cm



Milligan

II-8-110-21

Dura Dissector
21.5 cm



Davis

II-8-111-21

Dura Dissector sharp
21.5 cm



Dura Dissector

II-8-112-22

Dura Dissector
22 cm

Neurosurgery



Davis

II-8-113

Dura Dissector
24.5 cm



Love

II-8-114-19

Nerve Root Retractor
21.5 cm, 18 cm, 11 cm



Olivecrona

II-8-115-18

Brain Spatula
18 cm



Scoville

II-8-116-23

Nerve Root Retractor 8mm
23.5 cm



Holsher

II-8-117-24

Nerve Root Retractor 8mm
23.5 cm

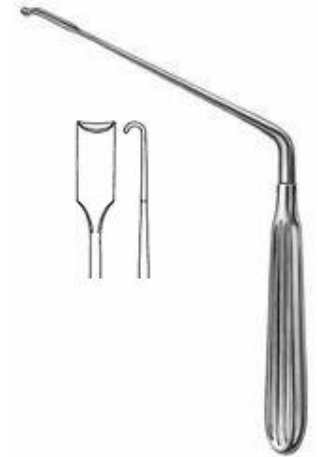

Scoville

II-8-118-19

Nerve Root Retractor 7mm
16.5 cm

Neurosurgery



Groningen
II-8-119-26
 Nerve Hook
 26.5 cm



Groningen
II-8-120-26
 Nerve Hook
 26.5 cm



Cushing
II-8-121-19
 Nerve Hook blunt
 19 cm , 28 cm

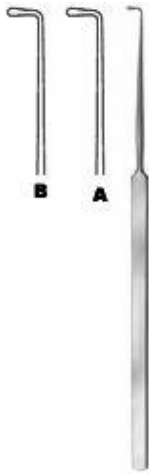

Cushing
II-8-122-19
 Nerve Hook
 19.5 cm , 28 cm



Smithwick
II-8-123-17
 Smithwick
 17 cm , 21 cm



Halle
II-8-125-20
 Dura Knife
 20 cm

Neurosurgery



Adson
II-8-126-20
 Dura Hook
 20 cm



Graham
II-8-127-16
 Dura Hook blunt
 16.5 cm



Sachs
II-8-128-18
 Dura Hook sharp
 18 cm



Toennis
II-8-129-15
 Dura Hook sharp
 14.5 cm



Frazier
II-8-130-13
 Dura Hook sharp
 13 cm , 18 cm



Krayenbuhl
II-8-131-01
 Nerve and Vessel Hooklet
 18.5 cm Fig. 1 , 18.5 cm Fig. 2

Neurosurgery



Cloward

II-8-132-16

Lamina Spreader
16 cm

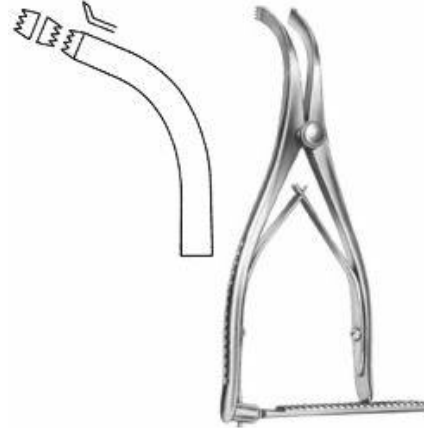

Inge

II-8-133-17

Lamina Spreader
16 cm

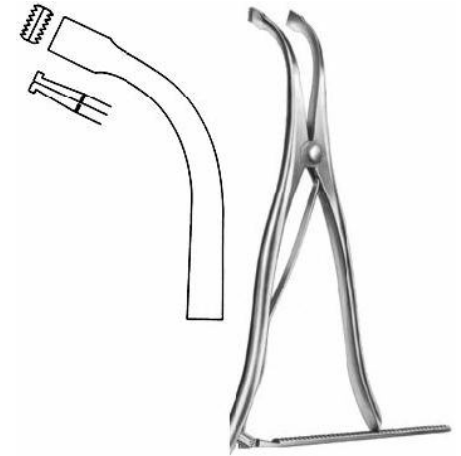

Inge

II-8-134-27

Lamina Spreader
25.5 cm

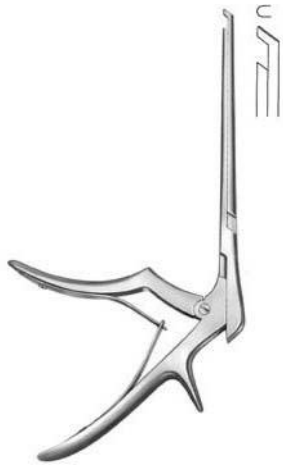

Ferris-Smith Kerrison

II-8-135-03

Laminectomy Punch 3mm downwards
cutting 40 degree shaft length 180 mm

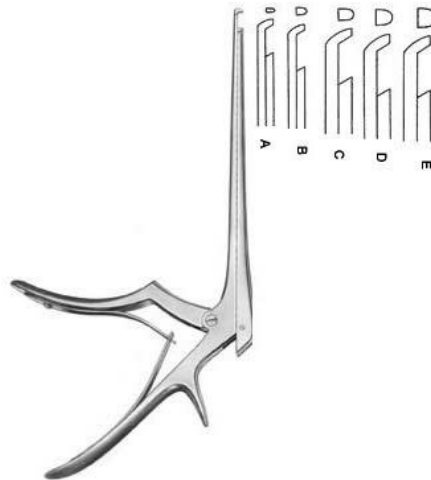

Ferris-Smith Kerrison

II-8-138-01

Laminectomy Punch upwards cutting shaft
length 180 mm
1 mm, 2 mm, 3 mm, 4 mm, 5 mm, 6 mm

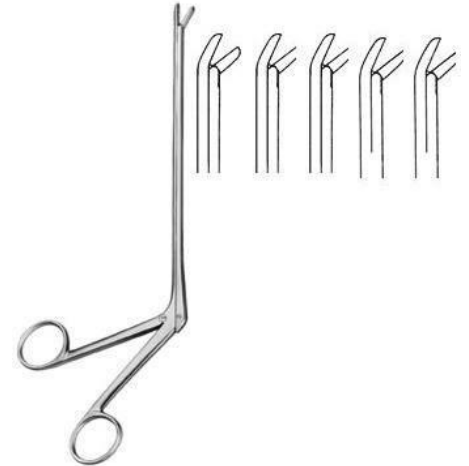

Cushing

II-8-139-01

Laminectomy Rongeur jaw 2 x 10 to 4 x 10
mm straight shaft length 180 mm

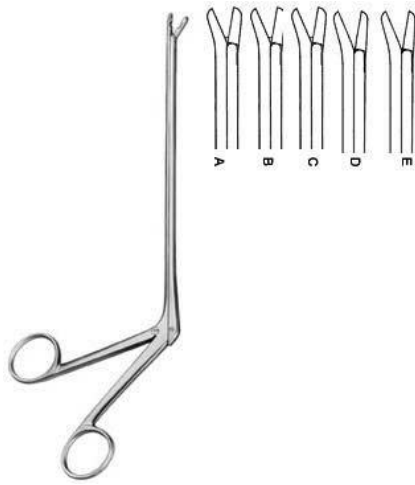

Cushing

II-8-140-01

Laminectomy Rongeur jaw 2 x 10 to 4 x 10 mm upwards 45 degree shaft length 120 mm

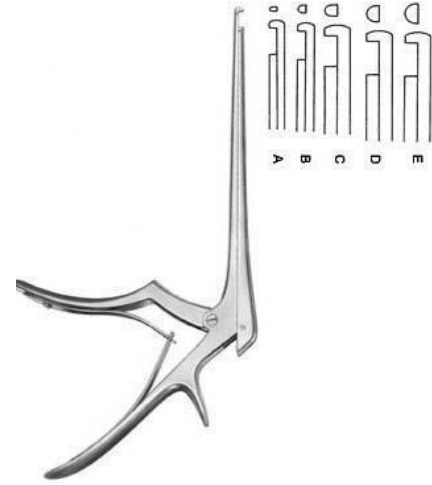

Ferris-Smith Kerrison

II-8-137-01

Laminectomy Punch
1 mm, 2 mm, 3 mm, 4 mm, 5 mm, 6 mm

Cardiovascular



Bone Shear

II-9-101-23

Bone Shear
23 cm



Rib Shear

II-9-102-22

Rib Shear
23 cm



Gluck

II-9-103-22

Rib Shears
21 cm



Giertz-Stille

II-9-104-27

Rib Shear
24.5 cm



Lebsche

II-9-105-24

Sternum Chisel
24.5 cm



Rib Retractor

II-9-106-01

Rib Retractor lateral blades 12 x 16 mm
spreading 95 mm

Size 1

Cardiovascular



Finochietto, Infant

II-9-107-01

Rib Retractor lateral blades 15 x 15 mm
spreading 75 mm
Size 1



Finochietto, Baby

II-9-108-01

Rib Retractor lateral blades 31 x 31 mm
spreading 100 mm
Size 1



Finochietto

II-9-109-01

Rib Retractor lateral blades 40 x 45 mm
spreading 135 mm
Size 1



Burford

II-9-110-01

Rib Retractor with two pairs of blades 47 x 62 mm + 65 x 62 mm, spreading 200 mm
Size 1



Castaneda

II-9-111-01

Rib Retractor lateral blades 10,5 x 32 mm
spreading 65 mm
Size 1



Finochietto (Modif.)

II-9-112-01

Rib Retractor lateral blades 14 x 15 mm
spreading 120 mm
Size 1

Cardiovascular



Haight

II-9-113-90

Rib Retractor lateral blades 30 x 30 mm
spreading 120 mm
Size 1



Morse-Favaloro

II-9-114-01

Sternal Retractor 4 movable blades 17 x 22
mm spreading 160 mm Sternal Retractor
Size 1

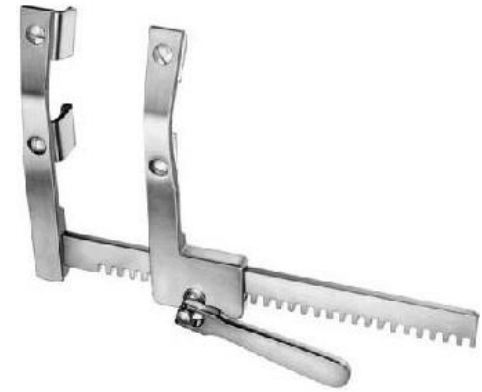

Morse

II-9-115-00

Sternal Retractor 4 movable blades 22 x 27
mm spreading 200 mm
Size 1



Tuffier

II-9-116-02

Rib Retractor lateral blades 22 x 27 mm
spreading 200 mm
Size 1

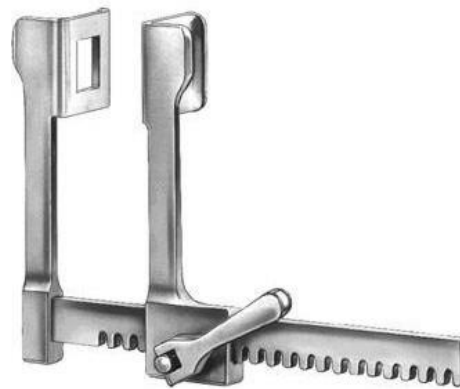

Finochietto, Baby

II-9-117-75

Rib Retractor lateral blades 14 x 15 mm
spreading 75 mm
Size 1



Finochietto

II-9-118-01

Rib Retractor lateral blades 30 x 45 mm
spreading 150 mm
Size 1



DeBakey

II-9-119-00

Rib Retractor spreading 150 mm
Size 1



DeBakey

II-9-120-00

Rib Retractor spreading 200 mm
Size 1



Thoracic Retractor

II-9-121-00

Thoracic Retractor
Size 1



Sellors

II-9-121-00

Rib Contractor
20 cm



Bailey-Baby

II-9-123-14

Rib Contractor
15.5 cm



Bailey

II-9-124-16

Rib Contractor
20 cm

Cardiovascular



Bailey-Gibbon

II-9-125-16

Rib Contractor
20 cm



Allison

II-9-126-30

Lung Spatula
29.5 cm, 32.5 cm



Price-Thomas

II-9-127-22

Bronchus Clamp
22 cm

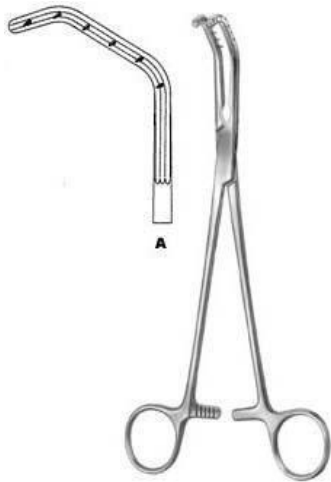

Price-Thomas

II-9-128-22

Bronchus Clamp
22 cm

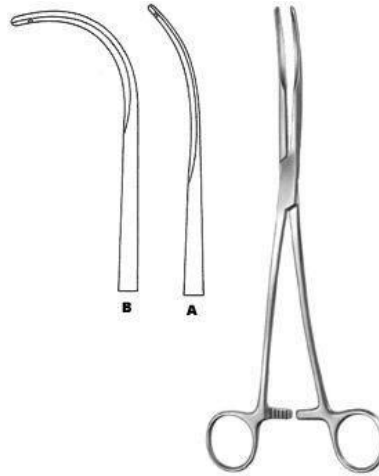

Semb

II-9-129-24

Bronchus Clamp
24.5 cm

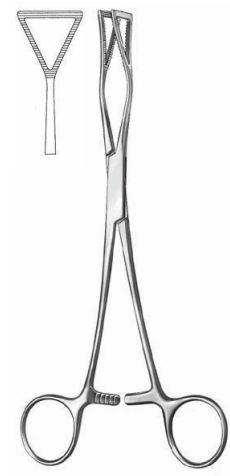

Lovlace

II-9-130-20

Lung Grasping Forceps
20.5 cm

Cardiovascular

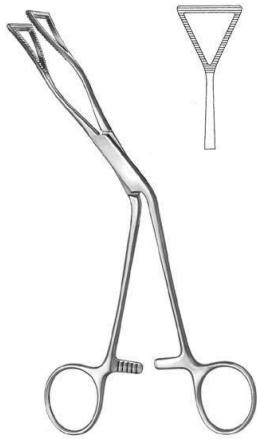

Lovelace

II-9-131-20

Lung Grasping Forceps
19 cm



DeBakey-Satinsky

II-9-132-07

Bulldog Clamp
7", 9 cm



Glover

II-9-133-06

Bulldog Clamp
6 cm



Santulli

II-9-134-07

Bulldog Clamp
7



Gregory, Soft

II-9-135-09

Bulldog Clamp
9 cm, 11 cm



Gregory

II-9-136-01

Bulldog Clamp
10.5 cm

Cardiovascular



DeBakey-Rankin

II-9-137-16

Haemostatic Forceps
16 cm



DeBakey-Mosquito

II-9-138-15

Haemostatic Forceps
15 cm



Ochsner

II-9-139-23

Aortic Clamp
23.5 cm



Diethrich

II-9-140-21

Aortic Clamp
22 cm

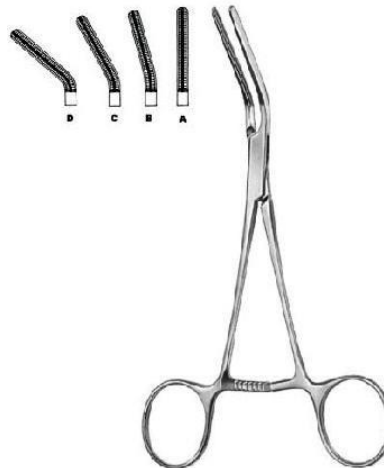

Dardik

II-9-141-00

Multi purpose Vascular Clamp
15 cm



Dale

II-9-142-18

Peripheral Vascular Clamp
18 cm

Cardiovascular

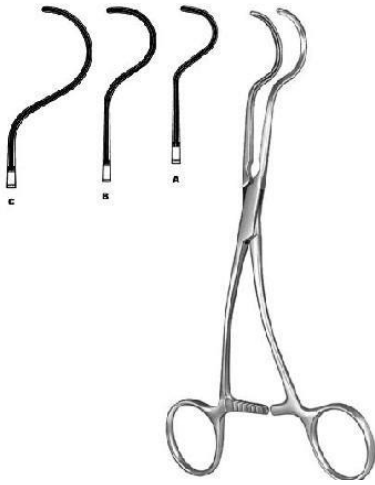

Dale

II-9-143-17

Peripheral Vascular Clamp
17.5 cm

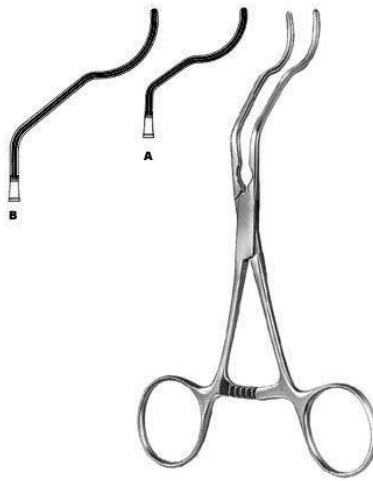

Gregory

II-9-144-14

Profunda Clamp
13 cm , 16 cm, 18 cm



Martin

II-9-145-16

Peripheral Vascular Clamp
16.5 cm



Husfeldt

II-9-146-18

Peripheral Vascular Clamp
17.5 cm



Husfeldt

II-9-147-18

Peripheral Vascular Clamp
18 cm

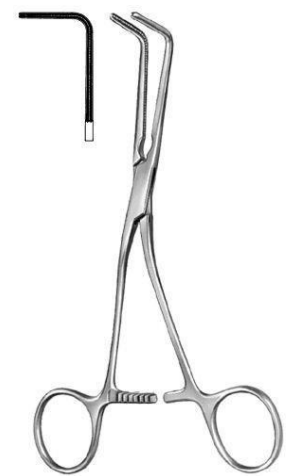

Husfeldt

II-9-148-17

Peripheral Vascular Clamp
17 cm

Cardiovascular



DeBakey

II-9-149-16

Vascular Forceps
16 cm

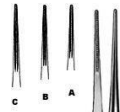

DeBakey

II-9-150-16

Vascular Forceps
16 cm



DeBakey

II-9-151-16

Vascular Forceps
16 cm

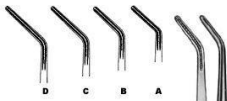

DeBakey

II-9-152-16

Vascular Forceps
16 cm

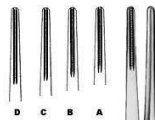

DeBakey

II-9-153-16

Vascular Forceps
16 cm



DeBakey

II-9-154-07

Bulldog Clamp
7

Cardiovascular



DeBakey

II-9-155-07

Bulldog Clamp

7



Applying Forceps

II-9-156-23

Applying Forceps

23.5 cm

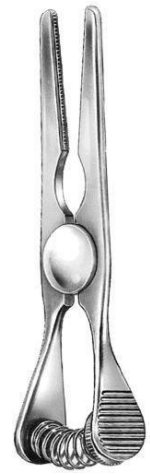

Glover

II-9-157-06

Bulldog Clamp

7



Glover

II-9-158-06

Bulldog Clamp

6.5 cm

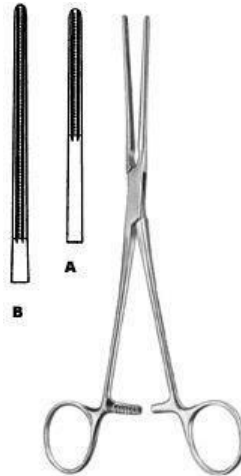

Potts

II-9-159-21

Coarctation Clamp

21 cm

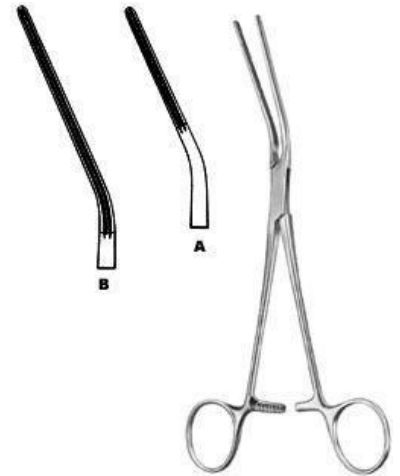

Potts

II-9-160-21

Coarctation Clamp

20.5 cm

Cardiovascular

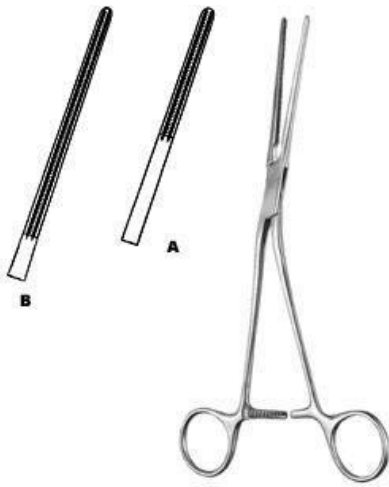

Potts

II-9-161-21

Coarctation Clamp
20.5 cm



Potts

II-9-162-22

Anastomosis Clamp
21.5 cm



Potts

II-9-163-22

Anastomosis Clamp
22 cm

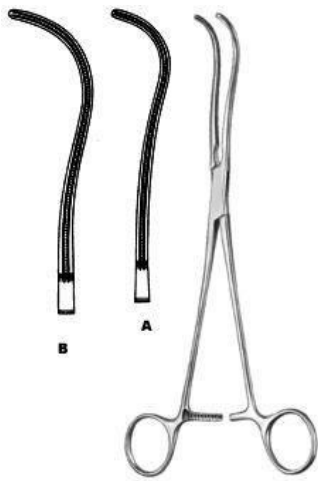

DeBakey

II-9-164-19

Ligature Forceps
19 cm



DeBakey

II-9-165-16

Peripheral Vascular Clamp
16 cm



DeBakey

II-9-166-19

Peripheral Vascular Clamp
16 cm

Cardiovascular

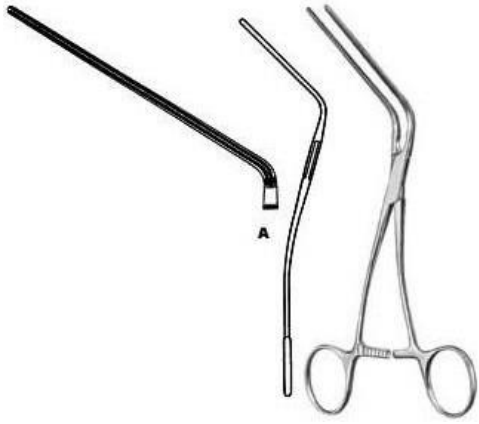

Leland-Jones

II-9-167-18

Peripheral Vascular Clamp
18 cm

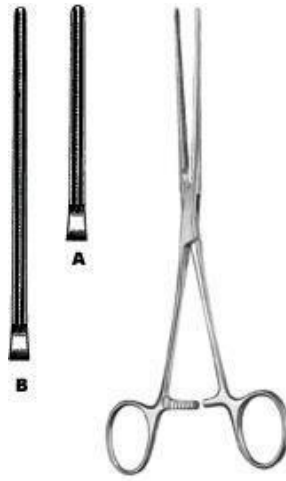

Bainbridge

II-9-168-15

Multi purpose Vascular Clamp
15 cm



Bainbridge

II-9-169-15

Multi purpose Vascular Clamp
15 cm

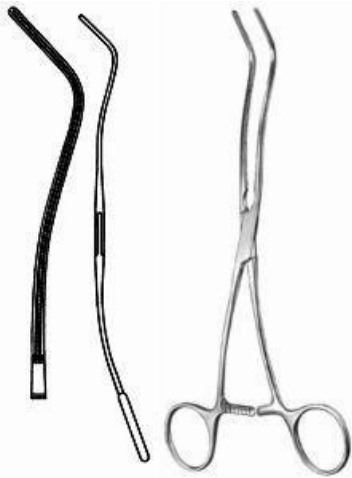

DeBakey

II-9-170-20

Multi purpose Vascular Clamp
20 cm



DeBakey

II-9-171-26

Aortic Aneurysm Clamp
26 cm



DeBakey

II-9-172-28

Aortic Aneurysm Clamp
28 cm

Cardiovascular

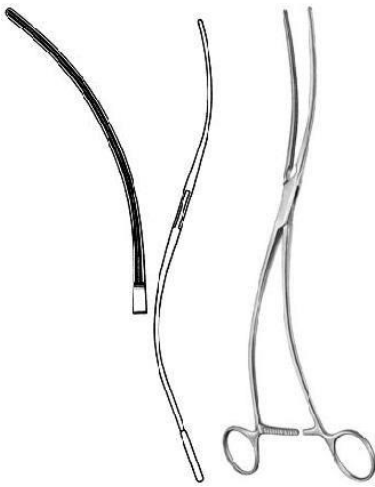

DeBakey

II-9-173-30

Aortic Aneurysm Clamp
30 cm



DeBakey

II-9-174-27

Aortic Clamp
27 cm



DeBakey

II-9-175-24

Ligature Forceps
24.5 cm



DeBakey

II-9-176-24

Ligature Forceps
24.5 cm



DeBakey

II-9-178-25

Ligature Forceps
27 cm

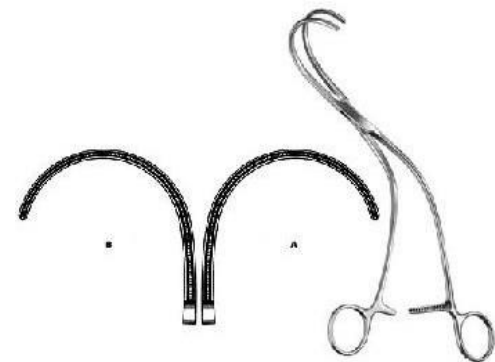

Weber

II-9-179-01

Aortic Clamp
24 cm

Cardiovascular



Satinsky

II-9-180-20

Tangential Occlusion Clamp
22 cm



Harken

II-9-181-01

Auricle Clamp
24.5 cm



Lees

II-9-182-23

Bronchus Clamp
23 cm



Lees

II-9-183-25

Bronchus Clamp
25 cm



Lambert-Kay

II-9-184-21

Anastomosis Clamp
22.5 cm



DeBakey

II-9-185-17

Anastomosis Clamp
16.5 cm

Cardiovascular



Morris-DeBakey

II-9-186-18

Aortic Clamp
16.5 cm



DeBakey-Bahnson

II-9-187-23

Aneurysm Clamp
23.5 cm

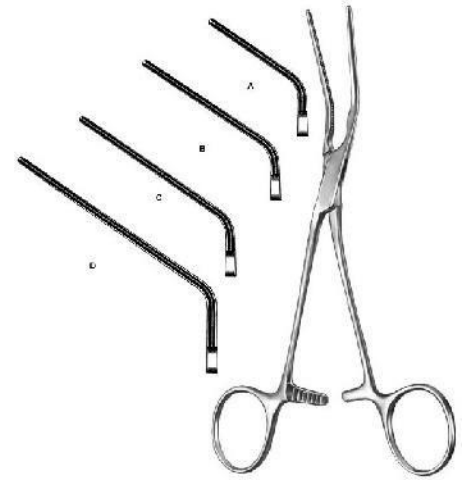

DeBakey

II-9-188-20

Multi purpose Vascular Clamp
18 cm

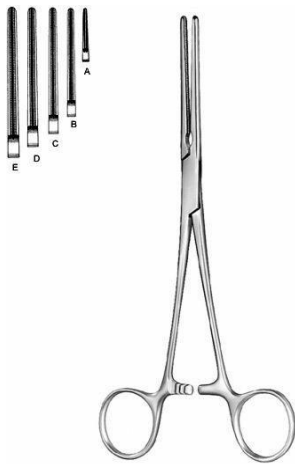

DeBakey-Mosquito

II-9-189-12

Haemostatic Forceps
12.5 cm



DeBakey-Mosquito

II-9-190-12

Haemostatic Forceps
12.5 cm



DeBakey

II-9-191-17

Multi purpose Vascular Clamp
17 cm

Cardiovascular



DeBakey

II-9-192-16

Multi purpose Vascular Clamp
16.5 cm

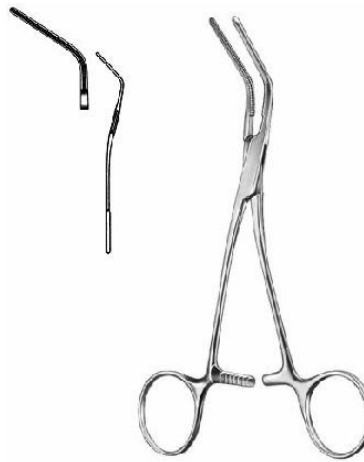

DeBakey

II-9-193-15

Multi purpose Vascular Clamp
16 cm

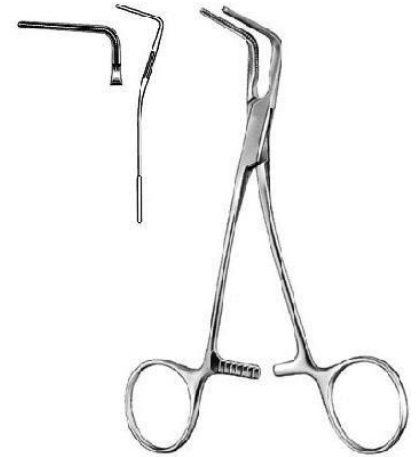

DeBakey

II-9-194-15

Multi purpose Vascular Clamp
16.5 cm



DeBakey

II-9-195-17

Multi purpose Vascular Clamp
16.5 cm



Glover

II-9-196-17

Multi purpose Vascular Clamp
17 cm



Glover

II-9-197-17

Multi purpose Vascular Clamp
17.5 cm

Cardiovascular

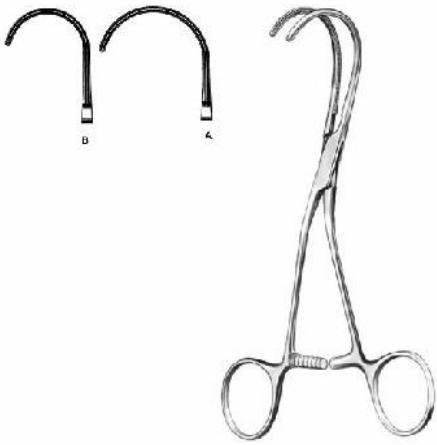

DeBakey

II-9-198-16

Multi purpose Vascular Clamp
16.5 cm

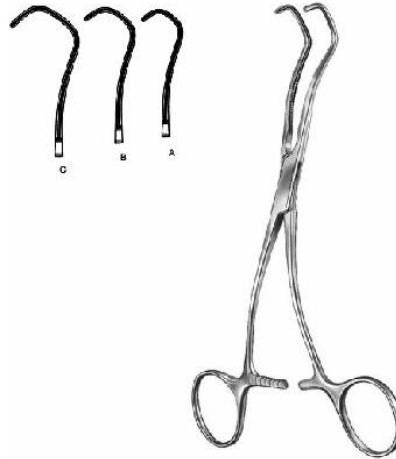

Derra

II-9-199-16

Anastomosis Clamp
16 cm Fig. 1, 17.5 cm Fig. 3, 18.5 cm Fig. 3



DeBakey-Beck

II-9-200-17

Anastomosis Clamp
17 cm



Cooley

II-9-201-16

Vascular Forceps
16 cm

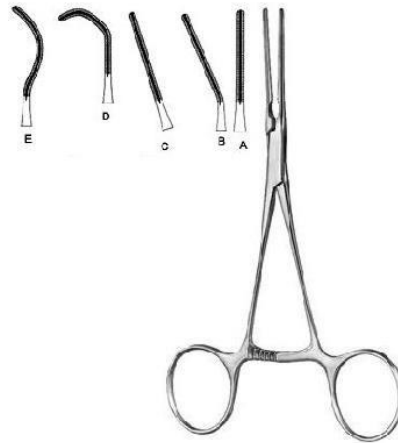

Cooley

II-9-202-01

Pediatric Vascular Clamp
14.5 cm



Cooley

II-9-203-21

Iliac Clamp
22 cm

Cardiovascular



Cooley

II-9-204-17

Anastomosis Clamp
17 cm

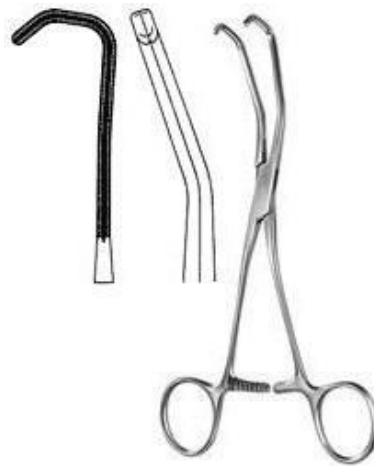

Cooley

II-9-205-17

Anastomosis Clamp
20 cm



Cooley

II-9-206-16

Anastomosis Clamp
17 cm



Cooley

II-9-207-15

Multi purpose Vascular Clamp
16 cm



Cooley

II-9-208-17

Multi purpose Vascular Clamp
17 cm



Cooley

II-9-209-17

Multi purpose Vascular Clamp
17 cm

Cardiovascular



Cooley

II-9-210-17

Multi purpose Vascular Clamp
17.5 cm

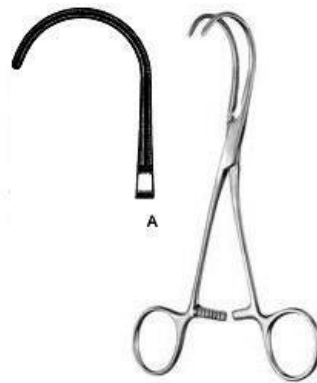

Cooley

II-9-211-16

Multi purpose Vascular Clamp
16.5 cm



Cooley-Derra

II-9-212-16

Anastomosis Clamp
16.5 cm



Cooley-Beck

II-9-213-17

Anastomosis Clamp
17 cm



Cooley

II-9-214-00

Aortic Dilator



Cooley

II-9-215-05

Vascular Dilator
14 cm / 5 ? 11

Cardiovascular



DeBakey
II-9-216-05

Vascular Dilator
19 cm

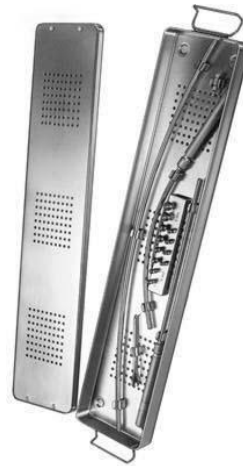

Martin
II-9-217-00

Tunneling Set complete set with three shafts, two handles and 12 tips in storage case.



Hach
II-9-218-01

Fasciotomy Knife with plastic handle
30 cm



Intima Spatula
II-9-219-18

Intima Spatula
18.5 cm

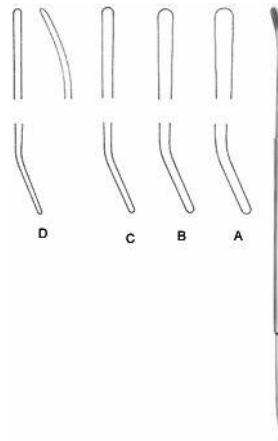

Robb
II-9-220-01

Vascular Dissector
24 cm Fig. 1 2,5 mm ? , 24 cm Fig. 2 2,0 mm ?



Crile
II-9-221-20

Nerve Hooklet
20 cm

Cardiovascular

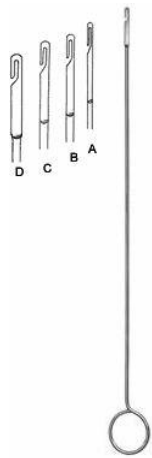

Ligature Catcher

II-9-222-15

Ligature Catcher
26 cm 1,5 mm



Subramanian-Miniature

II-9-223-15

Aortic Clamp 135 degree
15.5 cm

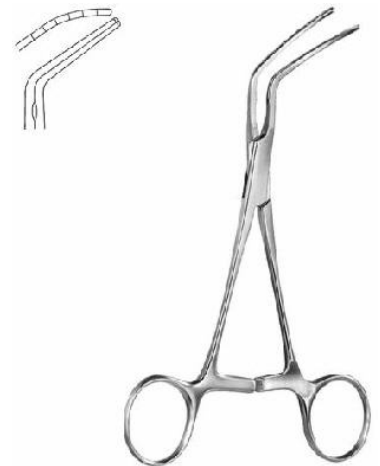

Subramanian

II-9-224-16

Aortic Clamp
16 cm

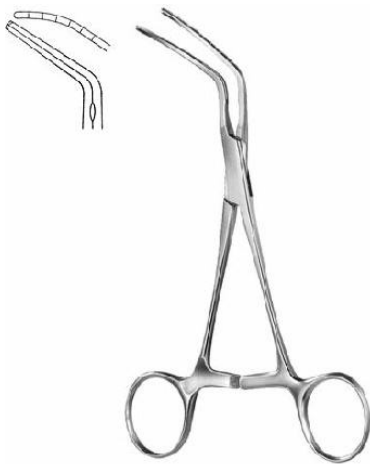

Subramanian

II-9-225-16

Aortic Clamp
14 cm Fig. 1 , 14 cm Fig. 2 , 14 cm Fig. 3

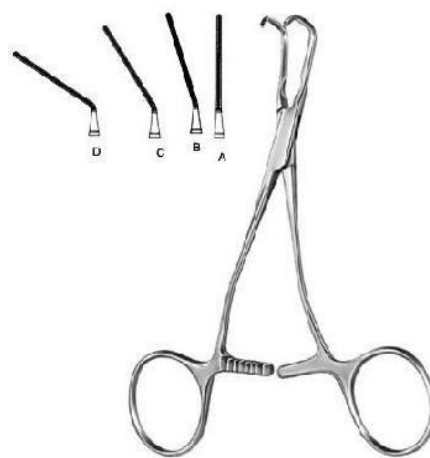

Pediatric Vascular Clamp

II-9-226-01

Pediatric Vascular Clamp



Pediatric Vascular Clamp

MI-9-227-16

Pediatric Vascular Clamp
16.5 cm



Pediatric Vascular Clamp

II-9-228-16

Pediatric Vascular Clamp
16 cm



Barraquer (Colibri)

II-11-101-03

Barraquer
Size 1



Bowman

II-11-102-07

Bowman
Size 1



Critchett

II-11-103-06

Critchett
Size 1

Tracheotomy

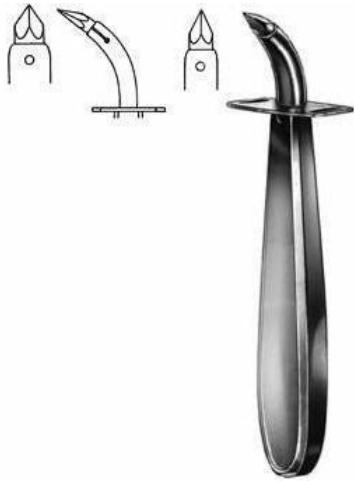

Weckermann

II-16-101-13

Tracheotomy Trocar
11.5 cm



Iterson

II-16-102-16

Tracheal Hook
17 cm



Rose

II-16-103-13

Tracheal Hook
13.5 cm



Luer

II-16-104-11

Tracheal Hook
11 cm

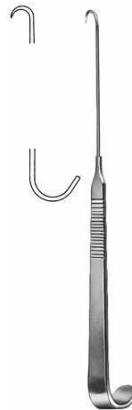

Tracheal Hook

II-16-105-15

Tracheal Hook
15 cm

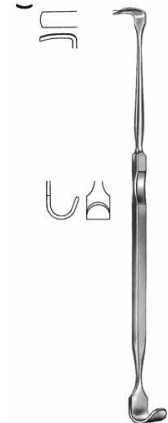

Lukens

II-16-106-17

Thymus Retractor
17.5 cm

Tracheotomy



Jackson
II-16-107-17
 Tracheal Hook
 18 cm



Kocher
II-16-108-15
 Goitre Enucleator
 16.5 cm



Kocher
II-16-109-15
 Goitre Enucleator
 16.5 cm



Hofmeister
II-16-110-21
 Goitre Enucleator
 20.5 cm

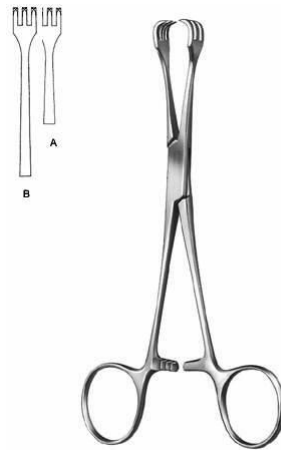

Lahey
II-16-111-15
 Goitre Grasping Forceps
 15.5 cm



Luer
II-16-112-04
 Tracheal Tube

Tracheotomy



Luer

II-6-113-08

Tracheal Tube



Chevalier-Jackson

II-16-114-04

Tracheal Tube outer tube closed inner tube
closed silver



Speaking Tube

II-16-115-08

Speaking Tube

Dermatology



Moncorps
II-17-101-14
 Milium Knife
 14 cm



Moncorps
II-17-102-00
 Spare Blade



Vidal
II-17-103-14
 Lupus Scraper
 13 cm



Wolff
II-17-105-01
 Lupus Curette
 14 cm



Kilner
II-17-106-15
 Skin Hooklet
 14.5 cm



Gillies
II-17-107-18
 Skin Hooklet
 18 cm

Dermatology



Kaye
II-17-108-03
 Face-lift Hook
 13 cm

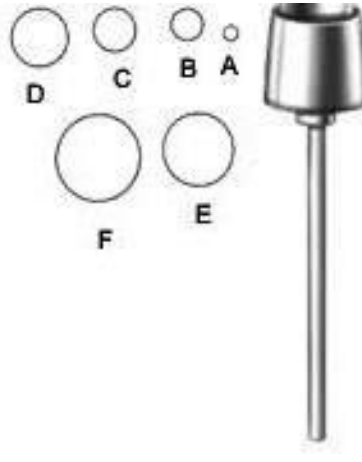

Dermal Punch
II-17-109-02
 Dermal Punch
 5.5 cm



Handle
II-17-110-00
 Handle
 8 cm

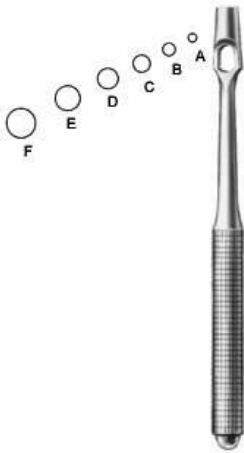

Keyes
II-17-111-02
 Dermal Punch
 11 cm



Unna
II-17-113-14
 Comedone Extractor
 14.5 cm



Saalfeld
II-17-114-10
 Comedone Extractor
 11 cm

Dermatology



Saalfeld

II-17-115-14

Saalfeld Comedone Extractor
14.5 cm



Schamberg

II-17-116-10

Comedone Extractor
9.5 cm



Katsch

II-17-117-14

Comedone Extractor
16 cm



Unna-Vidal

II-17-118-11

Comedone Extractor
11.5 cm



D'Assump?

II-17-119-15

Face-lift Forceps
18 cm



Gregory

II-17-120-14

Face-lift Scissors
14 cm

Dermatology

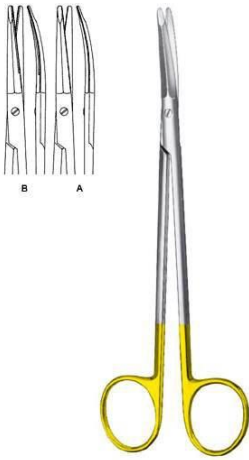

Kaye

II-17-121-15

Face-lift Scissors
15 cm, 18 cm



Stella-S

II-17-122-18

Face-lift Scissors
18 cm

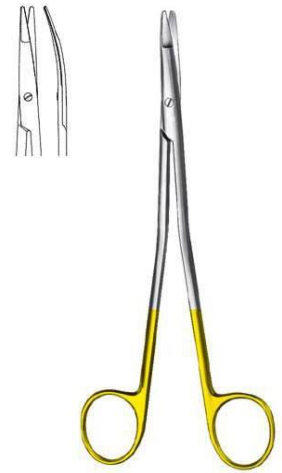

Gorney

II-17-123-18

Face-lift Scissors
18 cm



Freeman-Kaye

II-17-124-18

Face-lift Scissors
18 cm

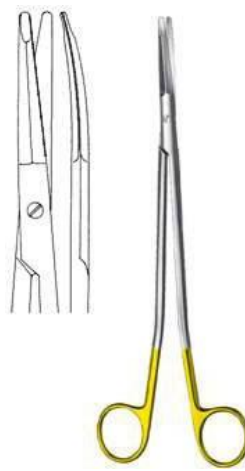

Freeman

II-17-125-00

Face-lift Scissors
23 cm



Fox

II-17-104-01

Lupus Curette
14 cm

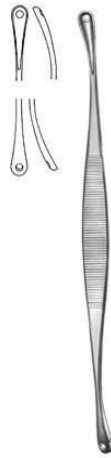

Unna

II-17-112-14

Comedone Extractor

14.5 cm

Intestines & Stomach



Allis-Baby

II-18-101-12

Intestinal and Tissue Grasping Forceps
13 cm

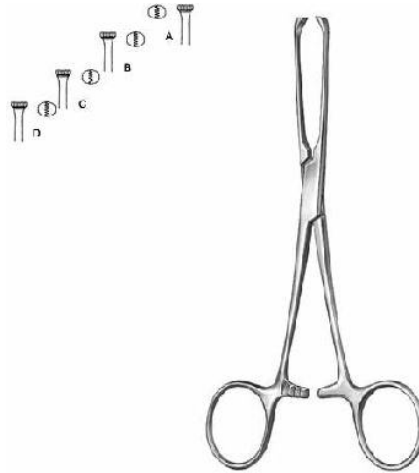

Allis

II-18-102-15

Intestinal and Tissue Grasping Forceps
15.5 cm, 19 cm, 25.5 cm

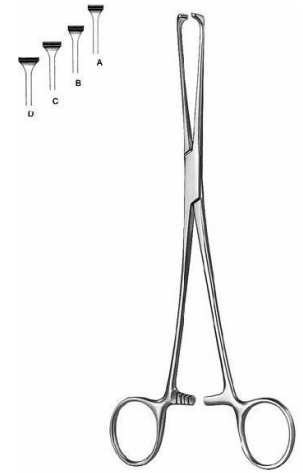

Allis

II-18-103-16

Intestinal and Tissue Grasping Forceps
15.5 cm, 20 cm, 24.5 cm, 30 cm



Allis-Adair

II-18-104-15

Intestinal and Tissue Grasping Forceps
16 cm



Boys-Allis

II-18-105-15

Intestinal and Tissue Grasping Forceps
15.5 cm



Thoms-Allis

II-18-106-20

Intestinal and Tissue Grasping Forceps
20.5 cm

Intestines & Stomach



Allis

II-18-107-20

Intestinal and Tissue Grasping Forceps
20 cm

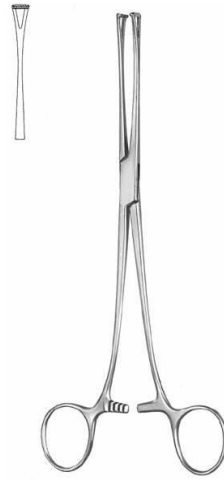

Lockwood

II-18-108-20

Intestinal and Tissue Grasping Forceps
20 cm



Williams

II-18-109-16

Intestinal and Tissue Grasping Forceps
16.5 cm

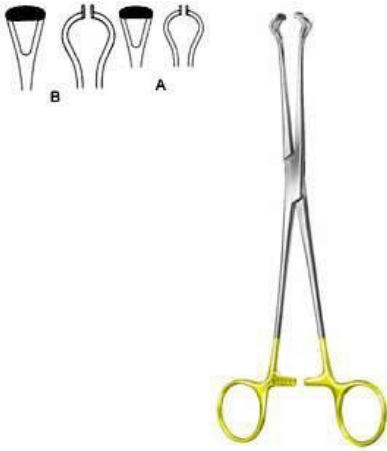

Babcock

II-18-110-16

Intestinal and Tissue Grasping Forceps
16.5 cm, 21 cm

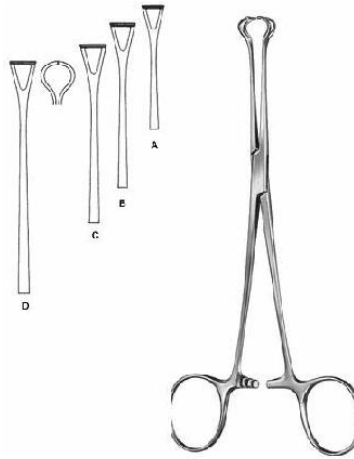

Babcock

II-18-111-16

Intestinal and Tissue Grasping Forceps
15.5 cm, 17.5 cm, 21 cm, 24 cm

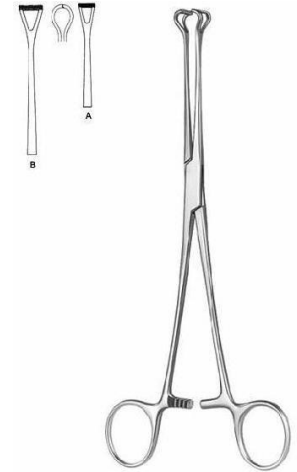

Babcock

II-18-112-16

Intestinal and Tissue Grasping Forceps
16.5 cm, 25.5 cm

Intestines & Stomach



Duval

II-18-113-20

Intestinal and Tissue Grasping Forceps
20.5 cm

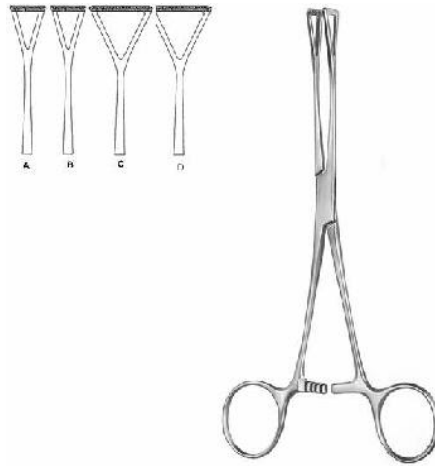

Duval

II-18-114-18

Intestinal and Tissue Grasping Forceps
18 cm, 25.5 cm, 23 cm

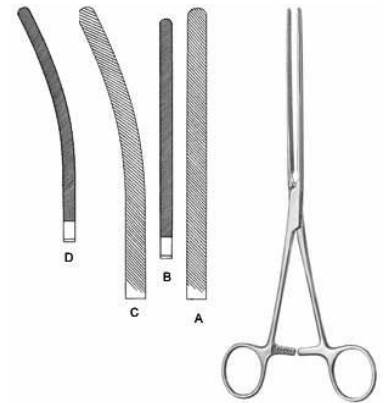

Doyen

II-18-115-21

Intestinal Clamp
21.5 cm, 23.5 cm



Doyen-Baby

II-18-116-18

Intestinal Clamp
18 cm, 17.5 cm

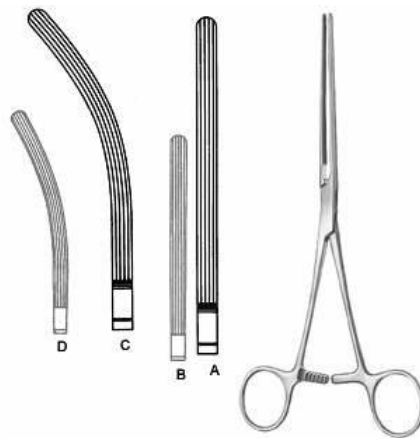

Mayo-Robson

II-18-117-21

Intestinal Clamp
21.5 cm, 23.5 cm, 23 cm

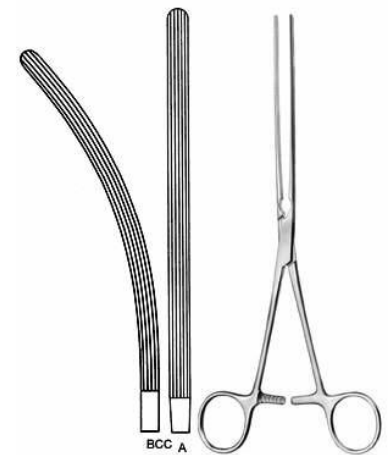

Mayo-Robson

II-18-118-25

Intestinal Clamp
25.5 cm, 24.5 cm

Intestines & Stomach

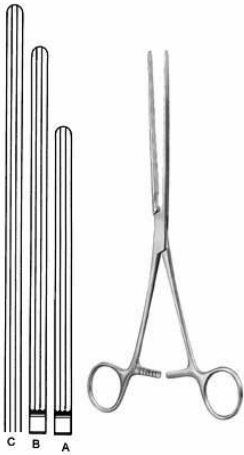

Kocher

II-18-119-22

Intestinal Clamp
22.5 cm, 25 cm, 28.5 cm

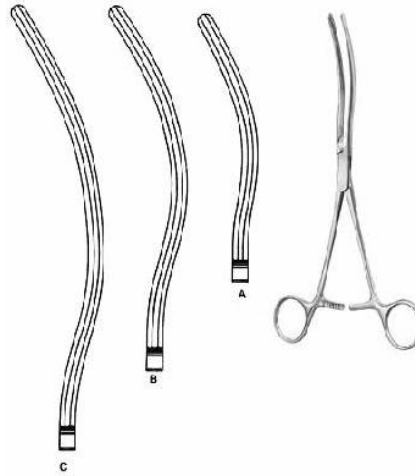

Kocher

II-18-120-22

Intestinal Clamp
22 cm, 24.5 cm, 27.5 cm



Allen

II-18-121-16

Intestinal Clamp
16 cm



Payr-Baby

II-18-122-15

Intestinal and Pylorus Clamp
15 cm

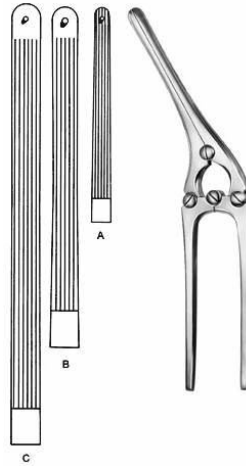

Payr

II-18-123-21

Intestinal and Pylorus Clamp
20.5 cm, 29 cm, 34.5 cm



Stone-Watt

II-18-124-07

Intestinal Anastomosis Clamp
8.5 cm, 10 cm

Intestines & Stomach



Stone-Watt
II-18-125-15
 Closing Forceps

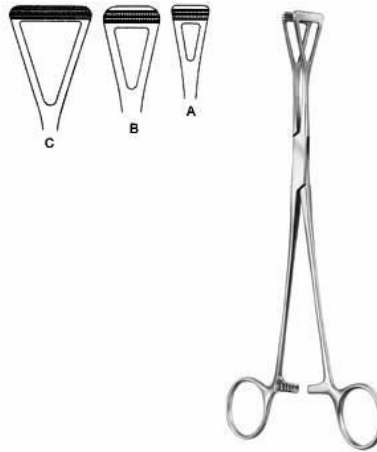

Scheibe
II-18-126-18
 Organ Grasping Forceps
 18 cm

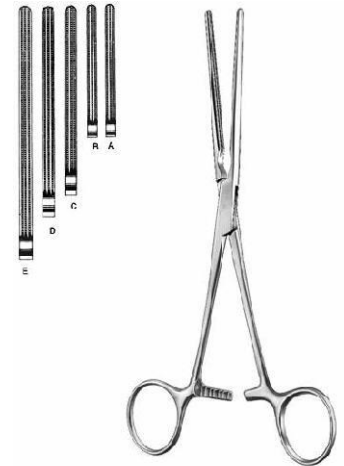

Doyen-Baby
II-18-127-13
 Intestinal Clamp
 14 cm, 17 cm

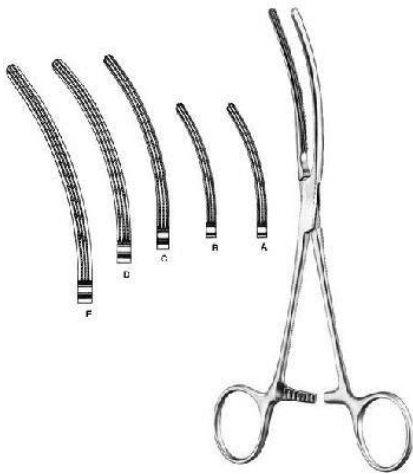

Doyen-Baby
II-18-128-13
 Intestinal Clamp
 13.5 cm , 17 cm



Mayo-Robson
II-18-129-25
 Intestinal Clamp
 26 cm



Mayo-Robson
II-18-130-25
 Intestinal Clamp
 25 cm

Intestines & Stomach

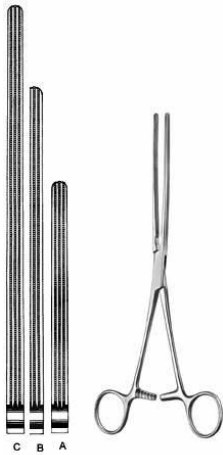

Kocher

II-18-131-22

Intestinal Clamp
22.5 cm, 28 cm



Kocher

II-18-132-22

Intestinal Clamp
22 cm, 25 cm, 27.5 cm

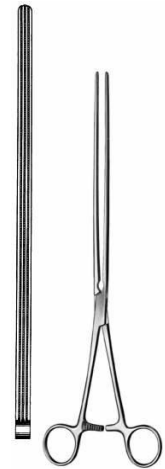

Scudder

II-18-133-33

Intestinal Clamp
33.5 cm

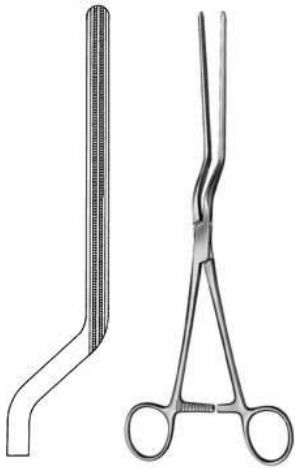

Brunner

II-18-134-24

Sigmoid Anastomosis Forceps
27 cm

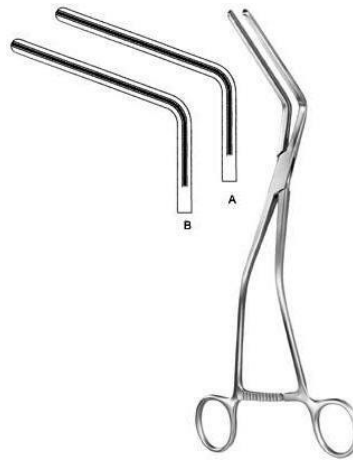

Hayes

II-18-135-26

Sigmoid Anastomosis Forceps
27 cm, 28 cm



Veidenheimer

II-18-136-23

Sigmoid Anastomosis Forceps
25 cm

Intestines & Stomach



Fehland

II-18-137-24

Sigmoid Anastomosis Forceps
24 cm

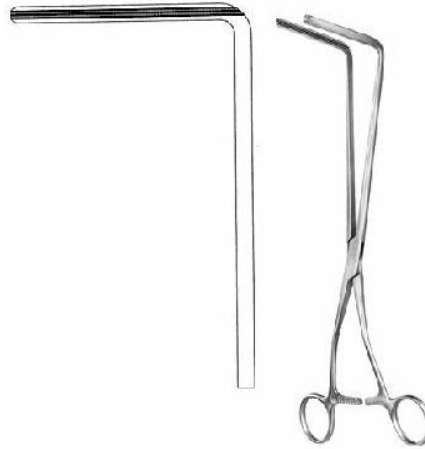

Resano

II-18-138-30

Sigmoid Anastomosis Forceps
28 cm



Sims

II-18-139-15

Rectal Speculum
15.5 cm



Sims

II-18-140-15

Rectal Speculum
15.5 cm



Mathieu

II-18-141-19

Rectal Speculum
19 cm



Alan-Parks

II-18-142-00

Alan-Parks
14 cm

Intestines & Stomach



McGinvey

II-18-143-19

Hemorrhoidal Grasping Forceps
19 cm



Handle For Biopsy Forceps

II-18-144-00

Handle for biopsy forceps



Rectal Biopsy Forceps

II-18-145-38

Rectal Biopsy Forceps

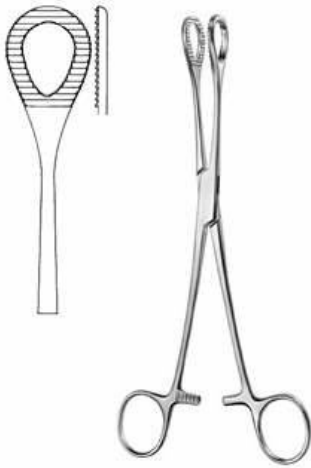

Heywood-Smith

II-18-146-21

Polypus Grasping Forceps
21 cm

Urology

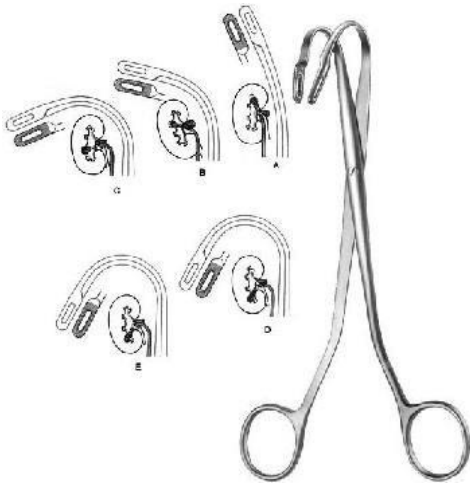

Randall

II-19-101-23 A

Kidney Stone Forceps

23 cm Fig. 1 , 21 cm Fig. 2, 21 cm Fig. 3

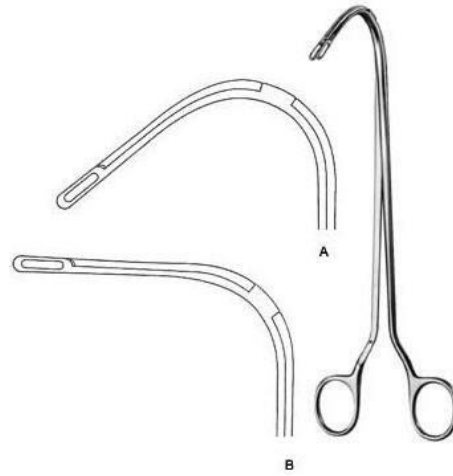

Randall

II-19-102-23 A

Kidney Stone Forceps

23 cm , 24.5 cm

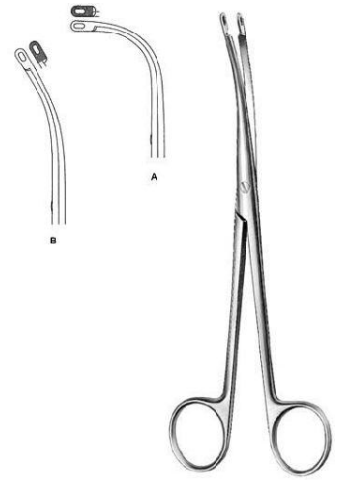

Heiming

II-19-103-16 A

Kidney Stone Forceps

16 cm Fig. 1, 17 cm Fig. 2

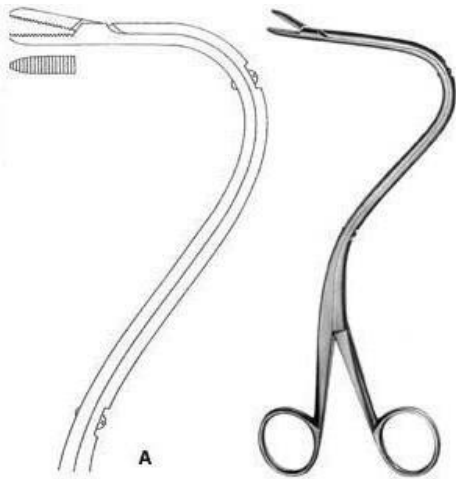

Elsasser

II-19-104-01 A

Nephrostomy Forceps

21 cm Fig. 1 , 21 cm Fig. 2



Bakes

II-19-105-01 A

Gall Duct Dilator

32 cm

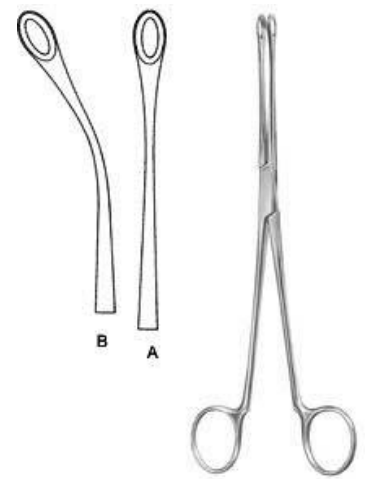

Blake

II-19-106-20 A

Gall Stone Forceps

21 cm



Mayo-Blake

II-19-107-20

Gall Stone Forceps
21 cm



Mayo-Blake

II-19-108-20

Gall Stone Forceps
21 cm



Mixer

II-19-109-22

Gall Stone Forceps
21.5 cm



Desjardins

II-19-110-23 A

Gall Stone Forceps
23 cm

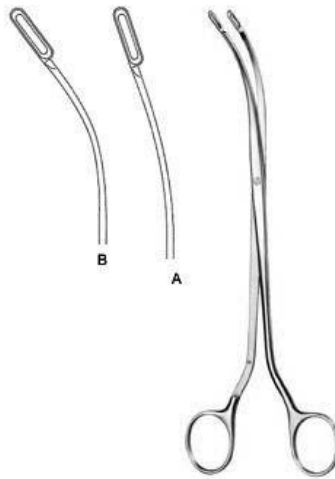

Desjardins

II-19-111-24 A

Gall Stone Forceps



Luer-Korte

II-19-112-01 A

Gall Stone Scoop
32 cm Fig. 0 , 32 cm Fig. 00 , 32 cm Fig. 000 , 32 cm Fig. 1, 32 cm Fig. 2, 32 cm Fig. 3, 32 cm Fig. 4

Urology

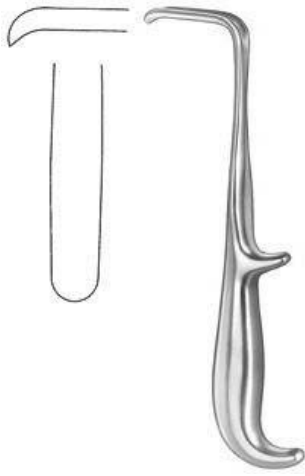

Young

II-19-113-21

Prostatic Retractor
21.5 cm



Young

II-19-114-22

Prostatic Retractor
20.5 cm



Young

II-19-115-21

Prostatic Retractor
22 cm

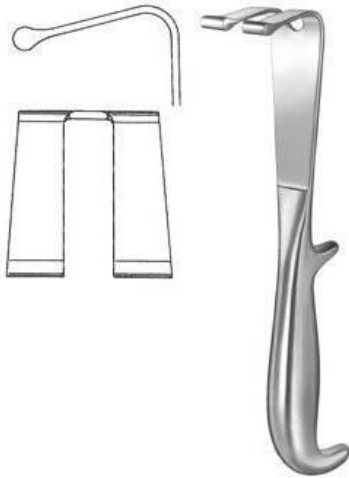

Young

II-19-116-22

Prostatic Retractor
21.5 cm



Millin

II-19-117-24

Capsule Forceps
24.5 cm

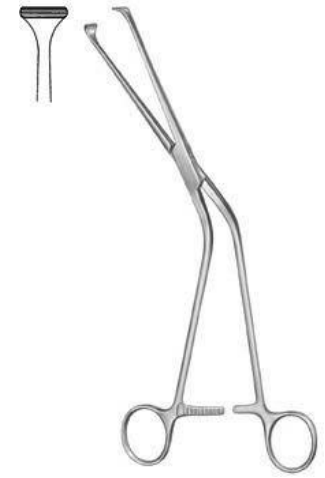

Millin

II-19-118-24

Capsule Forceps
22 cm

Urology

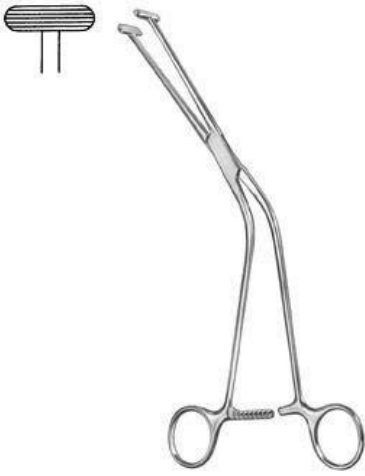

Millin

II-19-119-23

Capsule Forceps
24.5 cm

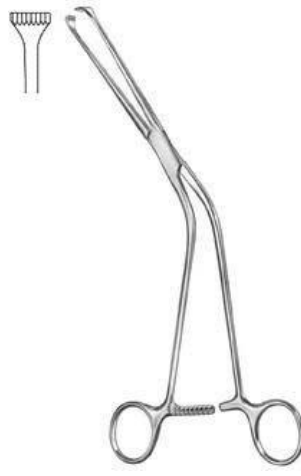

Millin

II-19-120-23

Capsule Forceps
22 cm

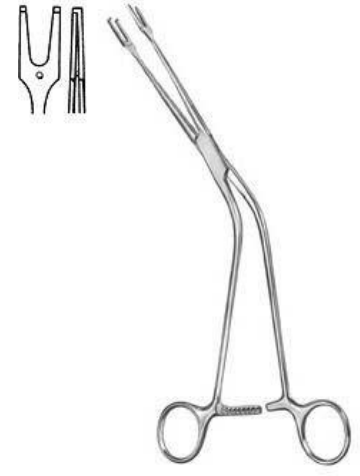

Millin

II-19-121-24

Ligature Carrying Forceps
24.5 cm



Millin

II-19-122-00

Bladder Neck Spreader
29



Thomson-Walker

II-19-123-00

Bladder Retractor



Judd-Masson

II-19-124-00

Bladder Retractor

Urology



Millin

II-19-125-00 A

Bladder Retractor



Legueu

II-19-126-27

Bladder Spatula
24 cm , 35 mm

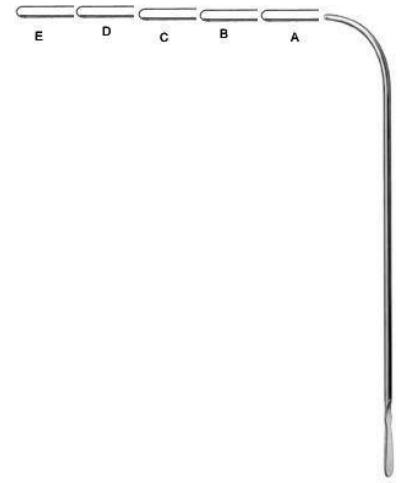

Van Buren

II-19-127-00 A

Urethral Sound
27.5 cm

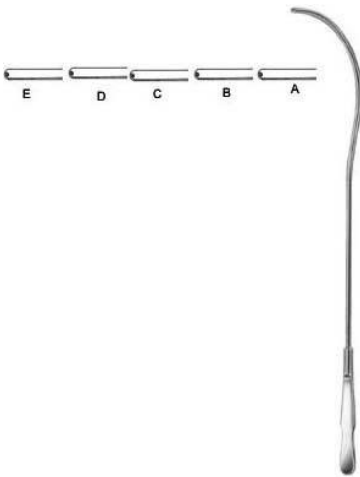

Guyon

II-19-128-10 A

Urethral Sound
26 cm

Gynecology



Cusco

II-20-101

Vaginal Speculum
75 x 32 mm, 85 x 35 mm



Cusco

II-20-102-01

Vaginal Speculum
75 x 18 mm



Cusco

II-20-103-01

Vaginal Speculum
80 x 22 mm, 100 x 25 mm , 105 x 27 mm



Cusco

II-20-104-01

Vaginal Speculum
75 x 34 mm , 85 x 37 mm



Collin

II-20-105-01

Vaginal Speculum
85 x 30 mm , 100 x 35 mm

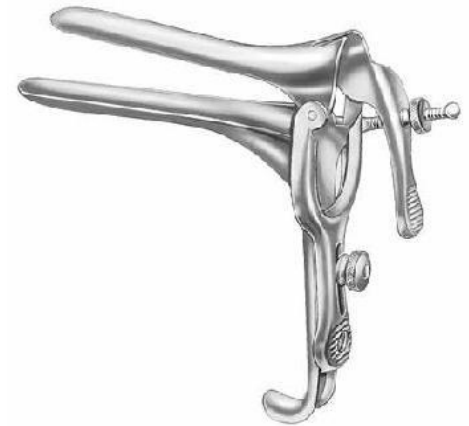

Pederson

II-20-106-01

Vaginal Speculum
75 x 13 mm, 100 x 22 mm

Gynecology



Grave

II-20-107-01

Vaginal Speculum
75 x 20 mm, 95 x 35 mm



Semm

II-20-108-01

Vaginal Speculum
100 x 20 mm, 105 x 27 mm



Sims

II-20-109-01

Vaginal Speculum
65 x 25 mm, 70 x 30 mm



Kristeller

II-20-110-01

Vaginal Speculum
70 x 27 mm



Kristeller

II-20-111-01

Vaginal Retractor
75 x 23 mm



Kristeller

II-20-112-01

Vaginal Speculum
Size 1



Kristeller
II-20-113-01
 Vaginal Speculum
 105 x 18 mm



Kristeller
II-20-114-01
 Vaginal Retractor
 110 x 14 mm



Kristeller
II-20-115-01
 Vaginal Speculum
 Size 1

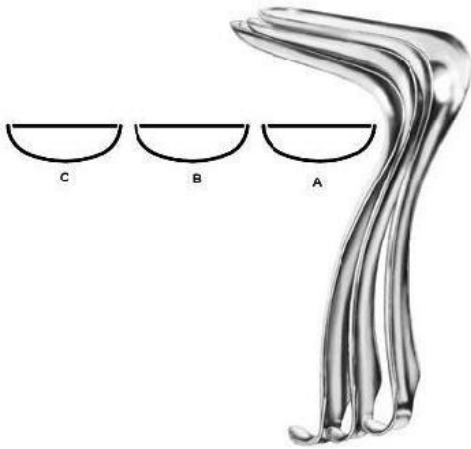

Kristeller
II-20-116-01
 Vaginal Speculum
 105 x 26 mm

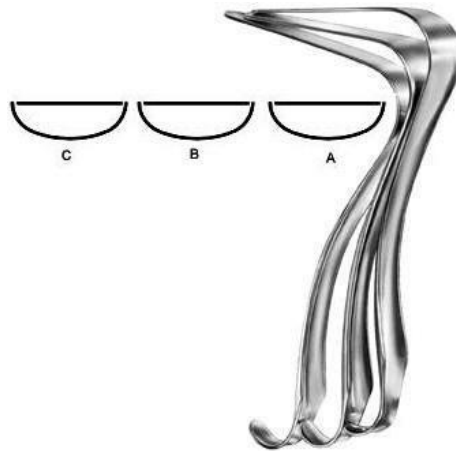

Kristeller
II-20-117-01
 Vaginal Retractor
 115 x 22 mm, 115 x 23 mm

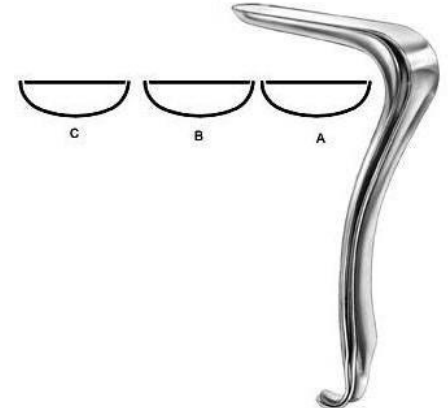

Kristeller
II-20-118-01
 Vaginal Speculum
 Size 1

Gynecology

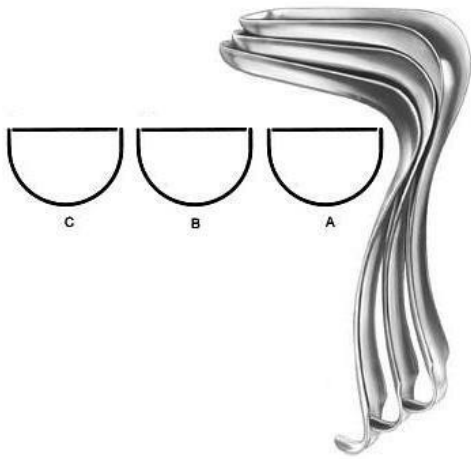

Kristeller

II-20-119-01

Vaginal Speculum
110 x 27 mm

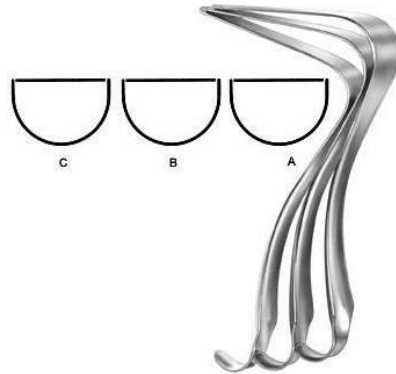

Kristeller

II-20-120-01

Vaginal Retractor
115 x 23 mm

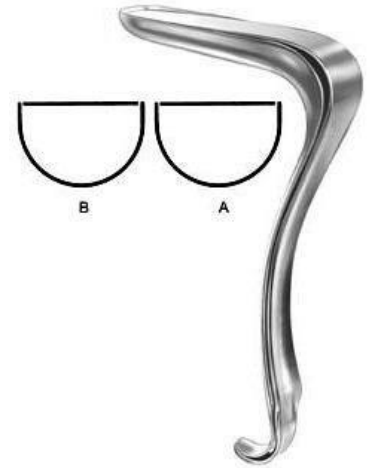

Kallmorgen

II-20-121-01

Vaginal Speculum



Kallmorgen

II-20-122-01

Vaginal Retractor
70 x 40 mm Fig. 1, 90 x 40 mm Fig. 2



Kallmorgen

II-20-123-01

Vaginal Speculum
70 x 33 mm, 90 x 33 mm

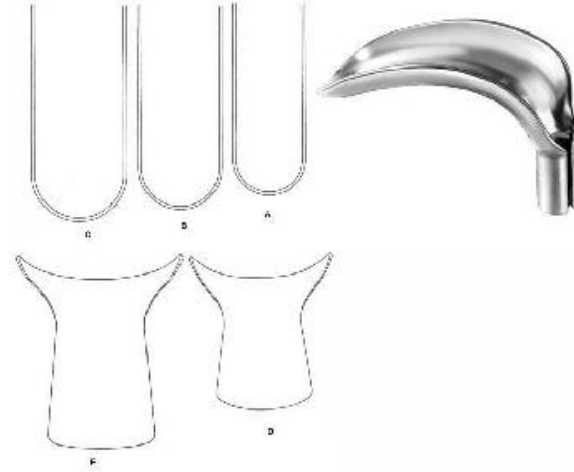

Scherbak

II-20-125-00

Vaginal Speculum
Size 1

Gynecology



Auvard

II-20-126-22

Vaginal Speculum
80 x 43 mm



Weissbarth

II-20-127-24

Vaginal Speculum
21 cm 80 x 42 mm



Breisky

II-20-128-20

Vaginal Speculum
29 cm 100 x 20 mm, 29 cm 100 x 25 mm



Kogan

II-20-129-24

Endocervical Speculum
25 cm 70 x 30 mm



Kogan

II-20-130-24

Endocervical Speculum
24.5 cm



Hegar

II-20-131-24

Uterine Dilator
18.5 cm 1,0



Hegar

II-20-132-02

Uterine Dilator
20 cm 1,0



Hank

II-20-133-10

Uterine Dilator
26.5 cm Fig. 9/10



Sims

II-20-134-32

Uterine Sound
33 cm



Valleix

II-20-135-25

Uterine Sound
29.5 cm



Braun

II-20-136-26

Uterine Depressor
27.5 cm



Schroder

II-20-137-25

Uterine Tenaculum Forceps
25.5 cm



Braun

II-20-138-25

Uterine Tenaculum Forceps
26 cm



Duplay

II-20-139-28

Uterine Tenaculum Forceps
25.5 cm



Beacham

II-20-140-26

Amniotome
26 cm



Skene

II-20-141-24

Uterine Tenaculum Forceps
24 cm

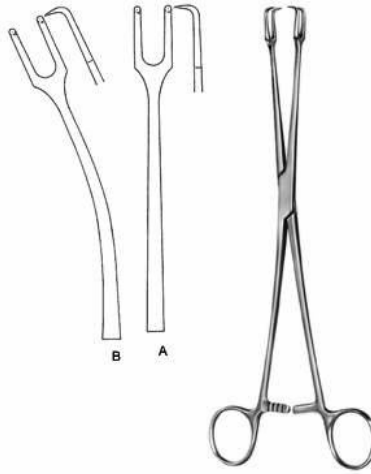

Schroder

II-20-142-24

Uterine Tenaculum Forceps
25 cm



Teale

II-20-143-23

Uterine Tenaculum Forceps
23.5 cm

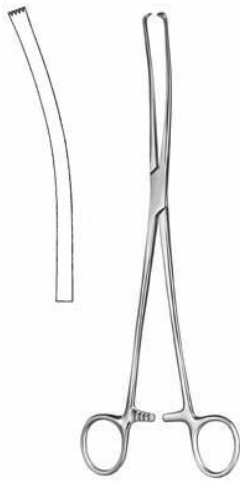

Iowa

II-20-144-26

Uterine Tenaculum Forceps
26 cm



Museux

II-20-145-24

Uterine Tenaculum Forceps
24 cm



Jacobs

II-20-146-21

Uterine Tenaculum Forceps
21 cm

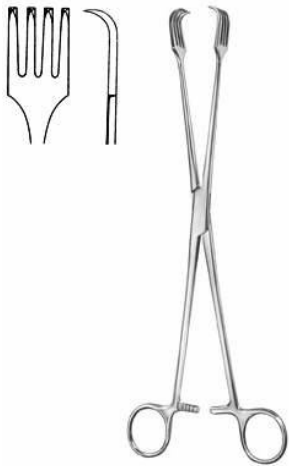

Uterine Tenaculum Forcep

II-20-147-26

Uterine Tenaculum Forcep
26.5 cm



Braun

II-20-148-16

Uterine Tenaculum Forceps
16 cm

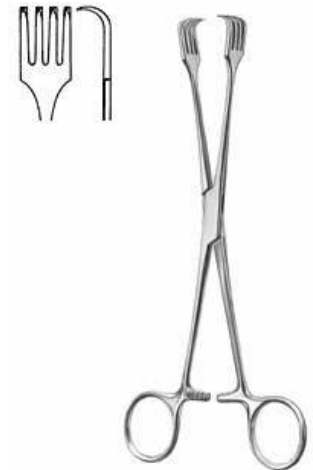

Czerny

II-20-149-21

Uterine Tenaculum Forceps
21 cm

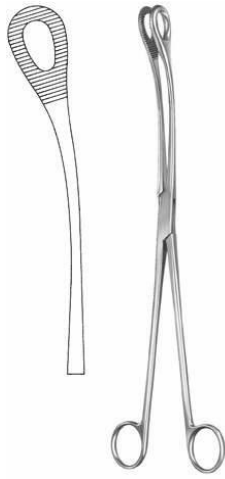

Kelly

II-20-150-32

Uterine Polypus Forceps
32 cm



Noto

II-20-151-27

Uterine Polypus Forceps
27 cm

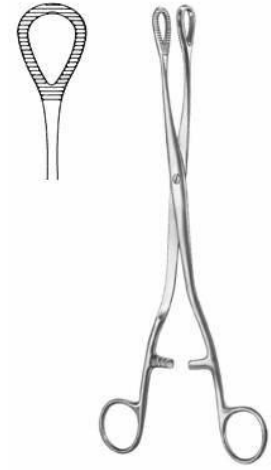

Heywood-Smith

II-20-152-25

Uterine Polypus Forceps
25 cm

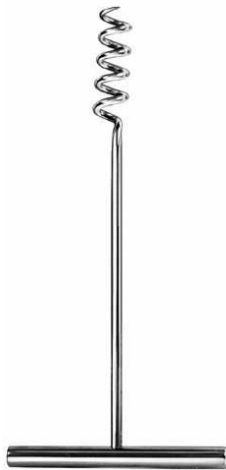

Doyen

II-20-153-17

Myoma Screw
17 cm



Doyen

II-20-154-17

Myoma Screw
14.5 cm



Segond

II-20-155-27

Myoma Knife
28 cm

Gynecology

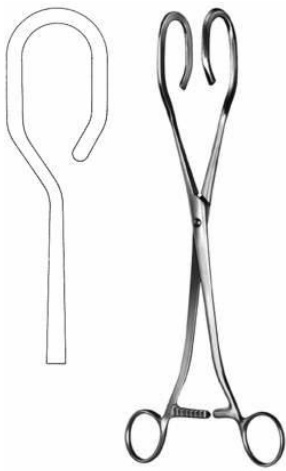

Dartigues

II-20-156-27

Uterine Seizing Forceps



Somer

II-20-157-27

Uterine Seizing Forceps
22.5 cm



Collin

II-20-158-25

Uterine Seizing Forceps jaw 40 mm wide
26 cm

28 cm



Ayre

MI-20-159-23

Conization Knife cutting edge 3,6 mm wide
23.5 cm



Emmett

II-20-160-03

Fistula Hook
22 cm Fig.3



Simon

II-20-161-22

Fistula Hook
21.5 cm

Gynecology



Simon
II-20-162-22
 Fistula Hook
 21.5 cm



Novak
II-20-163-23
 Suction Curette 4 mm ?
 24.5 cm



Kevorkian
II-20-164-23
 Uterine Biopsy Curette 6,0 mm ?
 30 cm



Munchen
II-20-165-27
 Uterine Biopsy Curette 4,8 mm ?
 27 cm



Gellhorn
II-20-166-23
 Uterine Biopsy Forceps jaw 8,6 mm wide
 24 cm



Faure
II-20-167-21
 Faure Uterine Biopsy Forceps
 21 cm

Gynecology

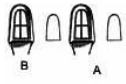

Schubert

II-20-168-21

Uterine Biopsy Forceps jaw 4,8 mm wide
21.5 cm, 28 cm



B

A



Thoms-Gaylor

II-20-169-22

Uterine Biopsy Forceps jaw 5,6 mm ?
21 cm, 23.5 cm

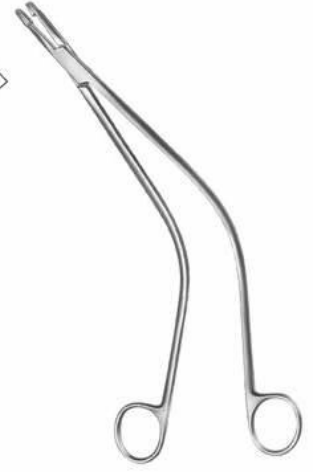

Schubert

II-20-170-26

Schubert Uterine Biopsy Forceps
25.5 cm

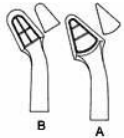

Van Doren

II-20-171-24

Uterine Biopsy Forceps jaw 4,9 mm wide
27 cm, 25.5 cm



Alexander

II-20-172-28

Uterine Biopsy Forceps jaw 5,1 mm wide
28 cm



Kevorkian

II-20-173-32

Uterine Biopsy Forceps
25 cm

Gynecology

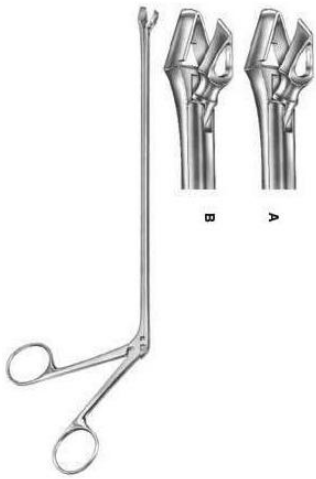

Schumacher
II-20-174-01

Uterine Biopsy Forceps jaw 4,6 / 5,4 mm
wide
24 cm



Schumacher
II-20-175-00

Uterine Biopsy Forceps
25 cm



IUP Grasping Forceps 3 Mm ?
II-20-176-22

IUP Grasping Forceps 3 mm ?
22 cm

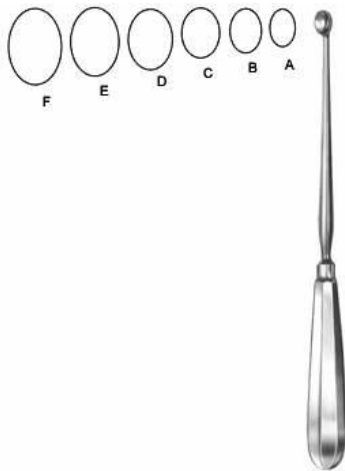

Simon
II-20-177-01

Uterine Scoop
24.5 cm 9,8 x 8,6 mm, 24.5 cm 11,6 x 8,3 mm



Simon

II-20-178-01

Uterine Scoop
30 cm 9,8 x 8,6 mm, 30 cm 11,6 x 8,3 mm



Recamier

II-20-179-05

Uterine Curette
31 cm Fig. 00 5 mm, 31 cm Fig. 0 6 mm

Gynecology



Recamier

II-20-180-05

Uterine Curette

31 cm Fig. 00 5 mm, 31 cm Fig. 0 6 mm



Sims

II-20-181-05

Uterine Curette

31 cm Fig. 00 5 mm, 31 cm Fig. 0 6 mm

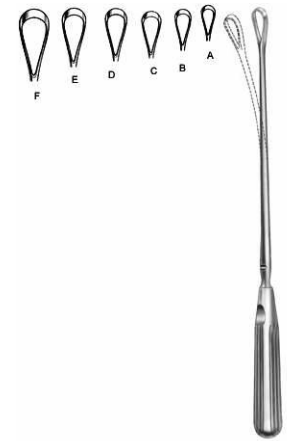

Sims

II-20-182-05

Uterine Curette

31 cm Fig. 00 5 mm, 31 cm Fig. 0 6 mm

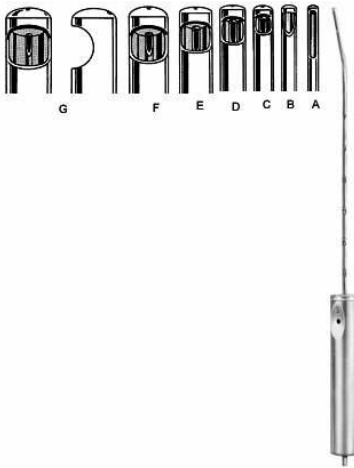

Suction Curette

II-0-183-03

Suction Curette

29 cm 3,0 mm ?, 29 cm 4,5 mm ?, 29 cm 6,0 mm ?

Obstetrics



Martin

II-21-101-34

Pelvimeter cm, inch scale
34 cm



Nagele

II-5-102-36

Obstetrical Forceps
35 cm, 40.5 cm



Simpson

II-5-103-30

Obstetrical Forceps
31 cm



Wrigley

II-5-104-28

Obstetrical Forceps
28 cm



Simpson

II-21-105-36

Obstetrical Forceps
36.5 cm



Kielland

II-21-106-41

Obstetrical Forceps
42 cm

Obstetrics

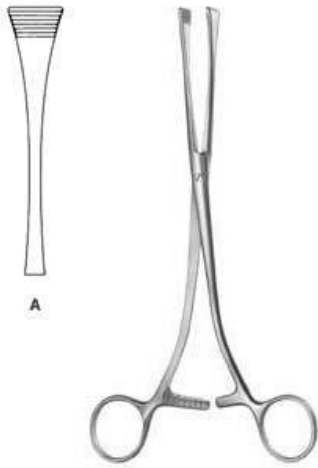

Green-Armytage

II-21-107-21

Uterine Clamp
21 cm



Sellheim

II-21-108-28

Obstetrical Lever
32 cm

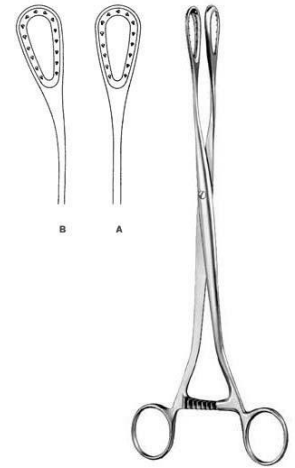

Sanger

II-21-109-27

Placenta and Ovum Forceps
27.5 cm, 27 cm

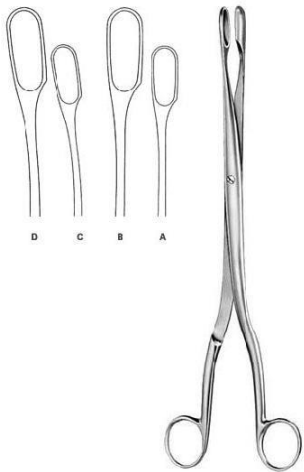

Winter

II-21-110-01

Placenta and Ovum Forceps
28 cm Fig. 1, 28 cm Fig. 2

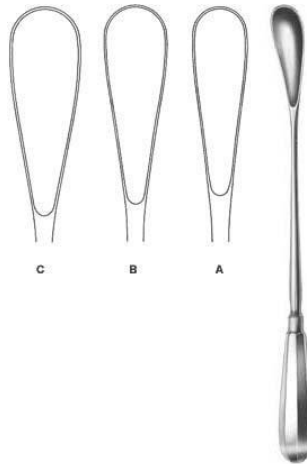

Cuzzi

II-21-111-01

Placenta Scoop
30 cm 14,5 mm, 30 cm 18 mm



Pestaloza

II-21-112-30

Placenta Scoop
30 cm

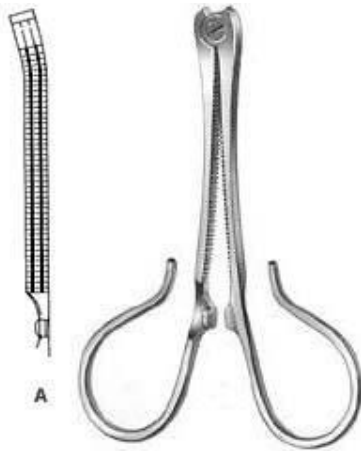

Kane

II-21-113-08

Umbilical Cord Clamp
8.5 cm



Collin

II-21-114-09

Umbilical Cord Clamp
8.5 cm



Irrigator
II-23-101-10
Sterilization
Size 1



Round Bowl
II-23-102-16
Sterilization
220 mm x 70 mm, 400 mm x 150 mm



Round Bowl
II-23-103-33
Sterilization
? x h 6,00 l



Flat Dish
II-23-104-11
Sterilization
? x h 0,20 l



Lid Only
II-23-105-11
Sterilization
Size 1



Stainless Steel
II-23-106-04
Sterilization
? x h 0,30 l



Round Dish

II-23-107-11

Sterilization

? x h 0,30 l, ? 128 x 38 mm 0,40 l



Flat Dish

II-23-108-11

Sterilization

? x h 0,15 l



Measurer

II-23-109-01

Graduated inside

100cc = 0,1 l



Measurer

II-23-110-02

Graduated Inside

0,25 l, 0,50 l



Petri Dish

II-23-111-10

with Lid ? x h



Petri Dish

II-23-112-09

without lid ? x h

Size 1



Lid For Petri Dishes

II-23-113-10

Sterilization
Size 1



Universal Tray

II-23-114-23

Sterilization
l x b x h



Instrument Tray

II-23-115-21

Sterilization
l x b x h



Universal Tray

II-23-116-23

Sterilization
l x b x h



Round Bowl

II-23-117-22

Sterilization
? x h



Metal Jar

II-23-118-30

Sterilization
? 30mm x 90 mm, ? 50mm x 100 mm



Instrument Box

II-23-119-16

lid with knob
l x b x h



Instrument Box

II-23-120-16

lid with knob
l x b x h



Instrument Box

II-23-121-20

Sterilization
l x b x h



Round Metal Box

II-23-122-06

Sterilization
? 75 mm x 75 mm, ? 100 mm x 60 mm



Medicine Cup Graduated Inside

II-23-123-25

Sterilization
25 cm



Medicine Cup Graduated Inside

II-23-124-50

Sterilization
50 cm



Tablet Tray

II-23-125-75

Sterilization
? 75 mm x 12 mm



Metal Cup

II-23-126-90

Sterilization
? 90 mm x 90 mm



Denture Cup

II-23-127-75

Sterilization
? 75 mm x 50 mm



Insert For Cup

II-23-128-75

Sterilization
? 73 mm x 75 mm



Kidney Dish

II-23-129-17

Kidney Dish
l x b x h



Placenta Pan

II-23-130-36

Sterilization
Size 1



Waste Cotton Collector

II-23-131-01

Sterilization
? 50 mm x 75 mm



Spirit Lamp

II-23-132-07

Sterilization
120 cm

Bone Surgery



Charri?Re
II-7-102-35

Amputation Saw
35 cm



Langenbeck
II-7-103-23

Amputation Saw
24.5 cm



Charriere
II-7-104-27

Amputation Saw
26.5 cm



Reamer
II-7-105-14

Reamer
13.5 cm



Perthes
II-7-106-18

Reamer
18 cm



Perthes
II-7-107-21

Reamer
21.5 cm

Bone Surgery



Reamer

II-7-108-14

Reamer
14 cm



Flat Trephine

II-7-111-18

Flat Trephine



Wire Twisting Forceps

II-7-112-01

Wire Twisting Forceps
15.5 cm, 18 cm, 20 cm

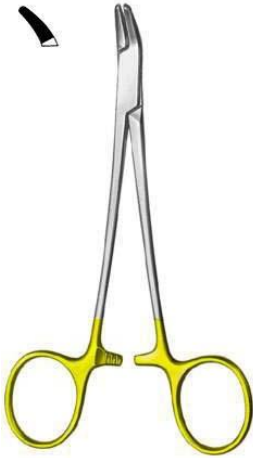

Wire Twisting Forceps

II-7-113-15

Wire Twisting Forceps
15.5 cm



Flat Nose Plier

II-7-114-17

Flat Nose Plier
18.5 cm



Wire Twisting Forceps

II-7-115-18

Wire Twisting Forceps
19 cm

Bone Surgery



Combi-Flat Nose Plier

II-7-116-15

Combi-Flat Nose Plier
15 cm

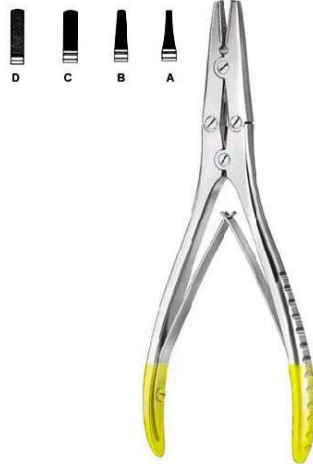

Flat Nose Plier

II-7-117-01

Flat Nose Plier
18 cm

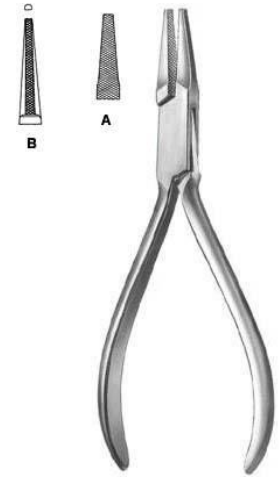

Flat Nose Plier

II-7-118-14

Flat Nose Plier
13.5 cm



Hackstock

II-7-119-16

Flat Nose Plier
16 cm



Flat Nose Plier

II-7-120-01

Flat Nose Plier
17.5 cm



Wire Cutting Pliers

II-7-121-18

Wire Cutting Pliers
18.5 cm

Bone Surgery



Wire Cutting Pliers

II-7-122-15

Wire Cutting Pliers
15 cm



Wire Cutting Pliers

II-7-123-18

Wire Cutting Pliers
17.5 cm



Demel

II-7-124-18

Wire Guide
28 cm Fig. 3 , 29 cm Fig. 2 , 31 cm Fig. 1

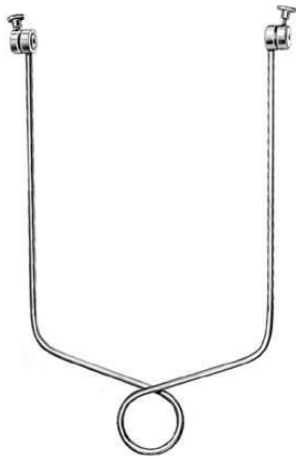

Bohler

II-7-125-15

Extension Bow



Kirschner

II-7-126-01

Extension Bow
18.5 cm , 26.5 cm



Traction Hook For Extension Bows

II-7-127-06

Traction Hook for Extension Bows

Bone Surgery



Kirschner
II-7-128-06
 Wire Drill
 6 cm, 12 cm



Kirschner
II-7-129-06
 Wire Drill
 14 cm, 16 cm



Kirschner
II-7-130-10
 Wire Drill
 31 cm



Kirschner
II-7-131-10
 Wire Drill
 12 cm, 16 cm, 18 cm



Kirschner
II-7-132-10
 Wire Drill
 31 cm



Buckley
II-7-133-02
 Chisel
 16 cm

Bone Surgery



Buckley
II-7-134-02

Gouge
16 cm



Stout
II-7-135-03

Bone Chisel
21 cm



Bone Chisel
II-7-112-01

Bone Chisel
18 cm



Bone Chisel
II-7-137-04

Bone Chisel
18 cm



Bone Chisel
II-138-04

Bone Chisel
17 cm



Bone Chisel
II-7-139-04

Bone Chisel
17 cm

Bone Surgery

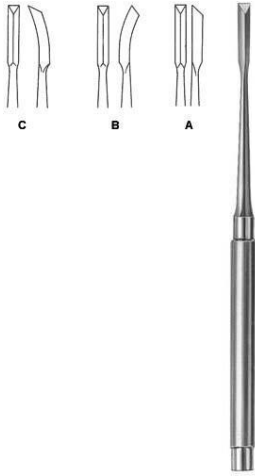

Gardner

II-7-112-01

Bone Chisel

17 cm 4mm



Snyder-O.S.U

II-7-141-03

Bone Chisel

16.5 cm 3mm , 16.5 cm 5.5mm



O.S.U.

II-7-142-01

one Chisel

17 cm 7mm



O.S.U.

II-7-143-01

one Chisel

17 cm 9mm



Osteotome

II-7-144-08

Osteotome

13.5 cm 8mm , 13.5 cm 10mm , 13.5 cm 12mm , 13.5 cm 14mm , 13.5 cm 16mm

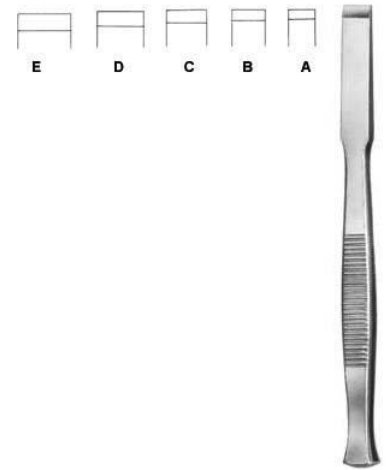

Chisel

II-7-145-08

Chisel

13.5 cm 8mm , 13.5 cm 10mm , 13.5 cm 12mm , 13.5 cm 14mm , 13.5 cm 16mm

Bone Surgery



Gouge

II-7-146-08

Gouge

13.5 cm 8mm , 13.5 cm 10mm , 13.5 cm 12mm , 13.5 cm 14mm , 13.5 cm 16mm



Partsch

II-7-147-02

Chisel

13.5 cm 2mm, 13.5 cm 3mm , 13.5 cm 4mm , 13.5 cm 5mm , 13.5 cm 6mm , 17 cm 2mm , 17 cm 3mm , 17 cm 4mm , 17 cm 5mm , 17 cm 6mm



Partsch

II-7-148-02

Gouge

13.5 cm 2mm, 13.5 cm 3mm , 17 cm 2mm , 17 cm 3mm

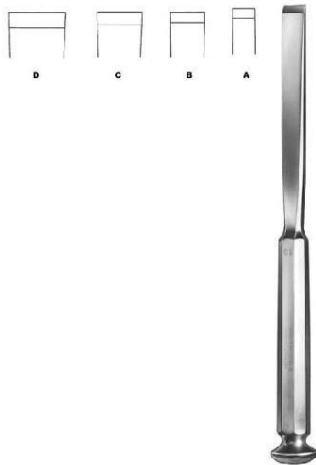

Stille

II--7-149

Chisel

20 cm 10mm , 20 cm 15mm , 20 cm 20mm , 20 cm 25mm



Stille

II--7-150

Osteotome

20 cm 10mm , 20 cm 15mm , 20 cm 20mm , 20 cm 25mm



Stille

II-7-151-10

Gouges

20 cm 10mm , 20 cm 15mm , 20 cm 20mm , 20 cm 25mm



Lambotte, Mini
II-7-152-02

Osteotome

12.5 cm 2mm , 12.5 cm 3mm , 12.5 cm 4mm , 12.5 cm 6mm



Lambotte
II-7-153-15

Osteotome

24 cm 15mm , 24 cm 20mm , 24 cm 25mm , 24 cm 30mm



Lambotte
II-7-154-15

Osteotome

24 cm 15mm , 24 cm 20mm , 24 cm 25mm , 24 cm 30mm



Smith-Petersen
II-7-155-06

Osteotome

20.5 cm 6mm , 20.5 cm 9mm , 20.5 cm 13mm



Smith-Petersen
II-7-156-06

Osteotome

20.5 cm 6mm , 20.5 cm 9mm , 20.5 cm 13mm , 20.5 cm 16mm , 20.5 cm 19mm



Smith-Petersen
II-7-157-09

Gouge

20.5 cm 9mm , 20.5 cm 14mm , 20.5 cm 19mm , 20.5 cm 25mm

Bone Surgery



Smith-Petersen

II-7-158-09

Gouge

20.5 cm 9mm , 20.5 cm 14mm , 20.5 cm 19mm



Hoke

II-7-159-03

Osteotome

17 cm 3mm , 17 cm 5mm , 17 cm 6mm , 17 cm 8mm

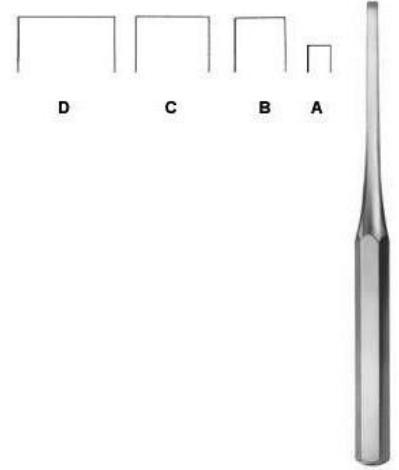

Hibbs

II-7-151-10

Osteotome

24.5 cm 6mm , 24.5 cm 13mm , 24.5 cm 19mm

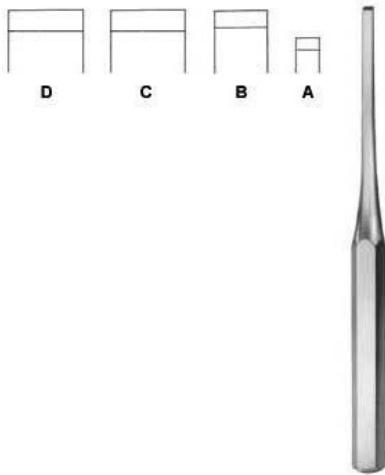

Hibbs

II-7-161-06

Chisel

24.5 cm 6mm , 24.5 cm 13mm , 24.5 cm 19mm

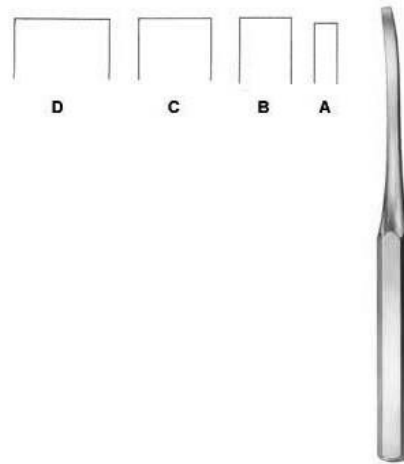

Hibbs

II-7-162-06

Osteotome

24.5 cm 6mm , 24.5 cm 13mm , 24.5 cm 19mm

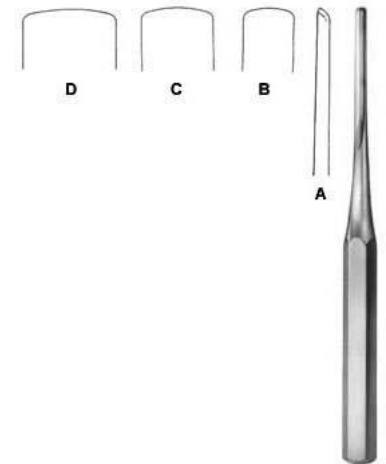

Hibbs

II-7-163-06

Hibbs

24.5 cm 6mm , 24.5 cm 13mm , 24.5 cm 19mm

Bone Surgery



Hibbs

II-7-164-06

Gouge
24.5 cm 6mm , 24.5 cm 13mm , 24.5 cm
19mm

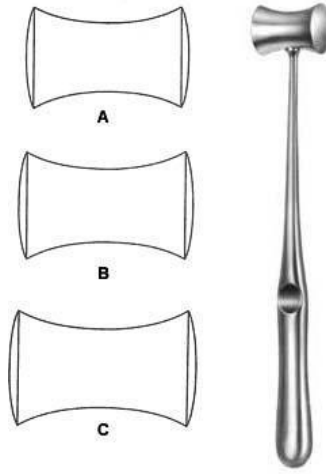

Williger

II-7-165-01

Mallet
24 cm

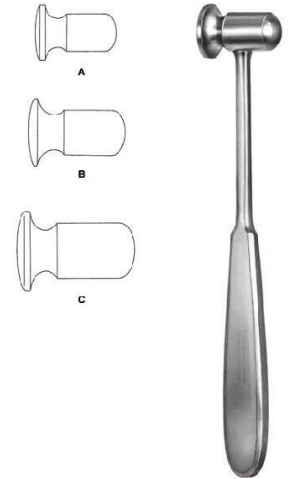

Doyen

II-7-166-01

Mallet
20.5 cm, 21 cm, 21.5 cm



Collin

II-7-151-10

Mallet
20 cm

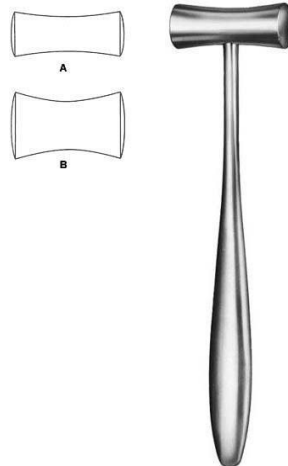

Lucae

II-7-168-01

Mallet
19.5 cm



Cottle

II-7-169-19

Mallet
19 cm

Bone Surgery



Williger
II-7-170-01
 Mallet
 16.5 cm



Mead
II-7-171-17
 Mallet
 19 cm



Partsch
II-7-172-18
 Mallet
 19 cm

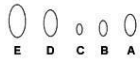

Schede
II-7-173-01
 Bone Curette Fig. 0 to 4
 17 cm



Kahre-Williger
II-7-201-04
 Periosteal Elevator
 4 mm, 5 mm, 7 mm



Periosteal Elevator
II-7-202-06
 Periosteal Elevator
 17 cm 6mm , 17 cm 8mm

Bone Surgery



Volkman
II-7-174-01

Bone Curette

17 cm Fig. 0, 17 cm Fig. 00, 17 cm Fig. 000, 17 cm Fig. 1, 17 cm Fig. 2, 17.5 cm Fig. 3, 17.5 cm Fig. 4



Doyen

II-7-203-17

Rib Raspatory

17.5 cm

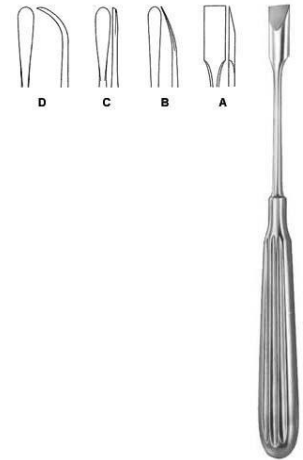

West

II-7-204-19

Periosteal Elevator, double-ended

17 cm, 17.5 cm



Bruns

II-7-175-01

Bone Curette

17 cm Fig. 0, 17 cm Fig. 00, 17 cm Fig. 000, 17 cm Fig. 1, 17 cm Fig. 2, 17 cm Fig. 3, 17 cm Fig. 4

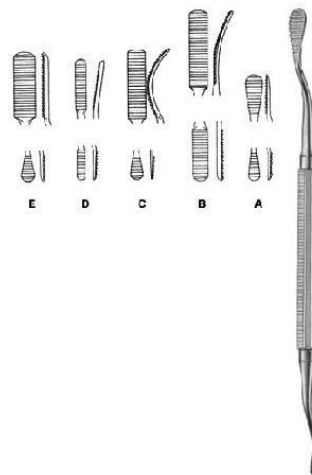

Miller-Colburn

II-7-209-01

Bone File

18 cm Fig. 1, 18 cm Fig. 2, 18 cm Fig. 3, 18 cm Fig. 4, 18 cm Fig. 5



Spratt

II-7-175-01

Bone Curette

17 cm Fig. 0, 17 cm Fig. 00, 17 cm Fig. 000, 17 cm Fig. 0000, 17 cm Fig. 1, 17 cm Fig. 2, 17 cm Fig. 3, 17 cm Fig. 4, 17 cm Fig. 5

Bone Surgery

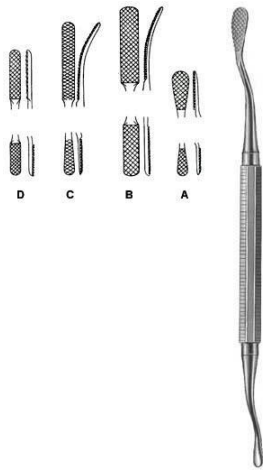

Miller-Colburn

II-7-210-01

Bone File

18 cm Fig. 1, 18 cm Fig. 2, 18 cm Fig. 3, 18 cm Fig. 4



Langenbeck

II-7-211-20

Elevator



Bruns

II-7-177-01

Bone Curette

23 cm Fig. 0 , 23 cm Fig. 00 , 23 cm Fig. 000 , 23 cm Fig. 1 , 23 cm Fig. 2 , 23 cm Fig. 3

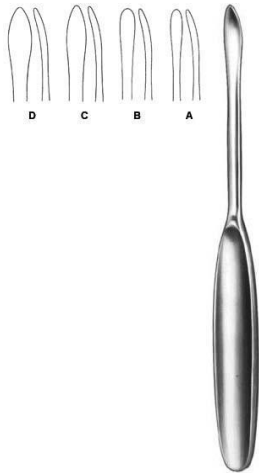

Martin-Langenbeck

II-7-212-01

Elevator

17 cm 5mm , 17 cm 7mm , 17 cm 8mm



Scoville

II-7-178-25

Bone Curette

25 cm



Vickers

II-7-213-17

Elevator

17 cm

Bone Surgery



Vickers
II-7-214-17
 Dissector
 17 cm

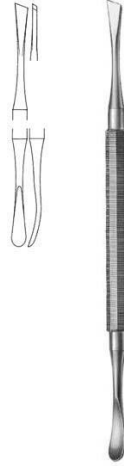

Simon
II-7-179-01
 Bone Curette
 25 cm Fig. 1 , 25 cm Fig. 2 , 25 cm Fig. 3 ,
 25 cm Fig. 4 , 25 cm Fig. 5



Williger
II-7-215-17
 Elevator
 16.5 cm 5.5mm



Modell USA
II-7-180-01

Bone Curette

16 cm Fig. 1, 16 cm Fig. 2, 16 cm Fig. 3, 16 cm Fig. 4



Williger
II-7-216-16
 Elevator
 16.5 cm 5.5mm



Mead
II-7-217-17
 Mallet
 19 cm

Bone Surgery



Periosteal Elevator

II-7-218-18

Periosteal Elevator



Hohmann

II-7-219-43

Bone Lever
23.5 cm



Modell USA

II-7-181-01

Bone Curette

15.5 cm Fig. 1 , 15.5 cm Fig. 2 , 15.5 cm Fig. 3 , 15.5 cm Fig. 4



Lempert

II-7-220-19

Bone Rongeur
19 cm



Modell USA

II-7-182-01

Bone Curette

15.5 cm Fig. 1 , 15.5 cm Fig. 2 , 15.5 cm Fig. 3 , 15.5 cm Fig. 4



Luer

II-7-221-17

Bone Rongeur
18 cm, 18.5 cm

Bone Surgery



Zaufal-Jansen

II-7-222-18

Bone Rongeur
18 cm



Halle

II-7-183-01

Bone Curette

21 cm Fig. 1 , 21 cm Fig. 2, 21 cm Fig. 3

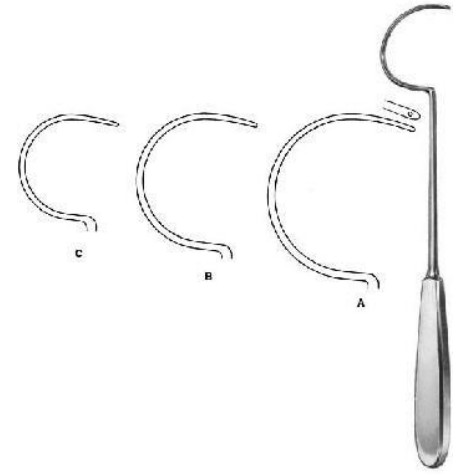

Demel

II-7-124-01

Wire Guide
31 cm Fig. 1



Volkmann

II-7-184-01

Bone Curette, double-ended
12.5 cm, 14.5 cm , 17 cm



Volkmann

II-7-185-13

Bone Curette, double-ended
13 cm , 16 cm



Bone Curette

II-7-186-21

Bone Curette, double-ended
21 cm

Bone Surgery



Williger

II-7-187-00

Bone Curette, double-ended
13.5 cm Fig. 00/0 , 13.5 cm Fig. 0/1 , 13.5 cm Fig. 1/2



Hemingway

II-7-189-11

Bone Curette, double-ended
18 cm



Hemingway

II-7-190-00

Bone Curette, double-ended
18.5 cm

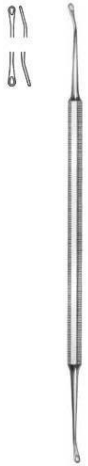

Bone Curette

II-7-191-01

Bone Curette, double-ended
17.5 cm

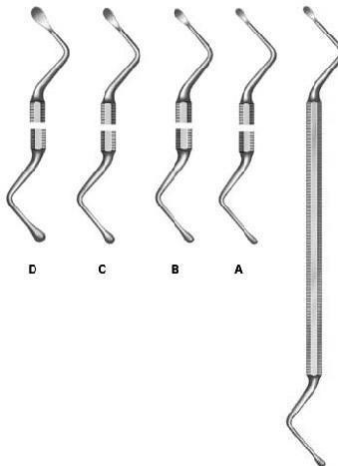

Lucas

II-7-192-11

Bone Curette, double-ended
18 cm

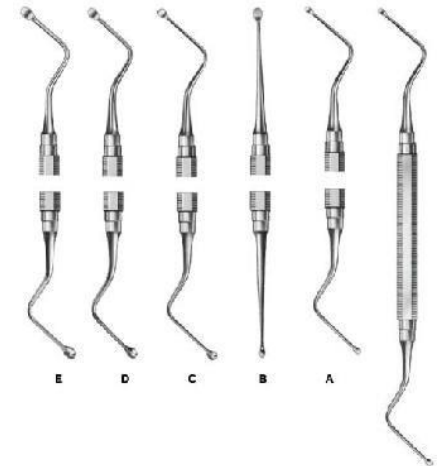

Miller-Colburn

II-7-193-00

Bone Curette, double-ended
17 cm Fig. 0, 17 cm Fig. 1 , 17 cm Fig. 2 , 17 cm Fig. 3

Bone Surgery

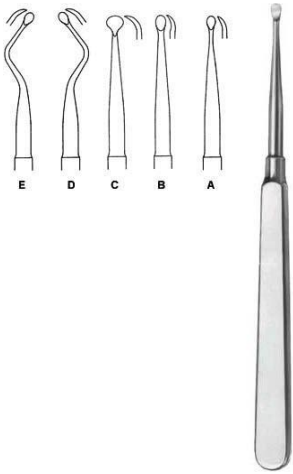

Molt

II-7-194-01

Bone Curette

17 cm Fig. 1 , 17 cm Fig. 2 , 17 cm Fig. 3 ,
17 cm Fig. 4

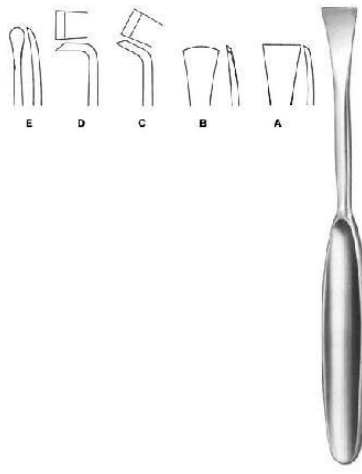

Martin-Langenbeck

II-7-195-01

Periosteal Elevator

19 cm 16mm



Langenbeck

II-7-196-18

Periosteal Elevator

18.5 cm



Langenbeck

II-7-197-19

Periosteal Elevator

19.5 cm



Periosteal Elevator

II-7-198-05

Periosteal Elevator

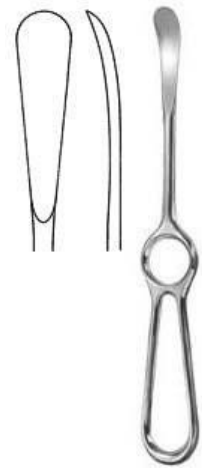

Sedillot

II-7-199-21

Periosteal Elevator

22 cm 15mm

Bone Surgery



Williger

II-7-200-13

Periosteal Elevator
12.5 cm 5mm



Kahre-Williger

II-7-201-04

Periosteal Elevator
4 mm, 5 mm, 7 mm

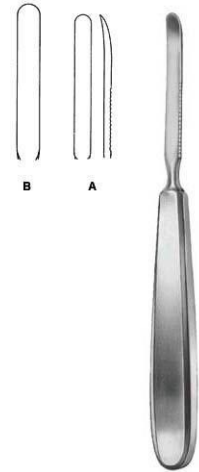

Periosteal Elevato

II-7-202-06

Periosteal Elevato
17 cm 6mm , 17 cm 8mm



Doyen

II-7-203-17

Rib Raspatory
17.5 cm

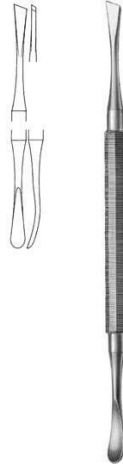

West

II-7-204-19

Periosteal Elevator, double-ended
18.5 cm



INTEREST INDUSTRY



**BMoh. Mahal Mattan Wala , dhara Sandha Kalan, Tehsil & Distt
Sialkot 51310 Pakistan.**



interestindustry@gmail.com



info@interestindustry.com



www.interestindustry.com